

NERC Marine Renewable Energy Knowledge Exchange Program

Tracking Harbour Porpoises in Tidal Rapids

A novel low cost autonomous platform to track the movement of harbour porpoises in tidal areas



Jamie Macaulay*¹, Jonathan Gordon¹, Doug Gillespie¹, Chloe Malinka¹,
Mark Johnson¹, Simon Northridge¹

¹Sea Mammal Research Unit, Scottish Oceans Institute, University of St Andrews,
St Andrews, Fife, KY16 8LB, UK

*jdjm@st-andrews.ac.uk

NOVEMBER 1, 2015



Contents

1	Introduction	1
2	Design Considerations.....	5
2.1	PLABuoy Array Design.....	5
2.2	PLABuoy Electronics.....	6
2.2.1	DAQ System	6
2.2.2	IMU units.....	9
2.3	PLABuoy Housing	10
2.4	Hydrophone Array.....	11
3	PLABuoy Software.....	12
4	Data Collection.....	14
5	Data Analysis.....	17
5.1	Modelling Array Movement.....	17
5.2	Analysis in PAMGUARD.....	18
6	Field Tests	20
6.1	Tests of Accuracy	20
6.2	Results.....	21
6.2.1	Example of Localisations from Calibration Trails	21
6.2.2	Calibration Trials with Array Movement Modelling.....	23
6.2.3	Accuracy Compared to Boat Based System	23
6.3	Porpoise Dive Profiles	25
7	Discussion and Conclusion	27
8	References	30
8.1	External Data.....	31

1 Introduction

As nations seek to reduce their reliance on energy from fossil fuels, developers are turning to the marine environment as a potential source of low carbon energy. This is leading to new types of anthropogenic activity and the industrialisation of marine areas. One newly developing marine renewable sector is tidal energy and in the UK and elsewhere there is interest in utilising strong tidal currents to power underwater turbines. The majority of these devices extract energy using large, unprotected, freely rotating blades, which pose a potential collision hazard for larger marine animals. The tips of some proposed blades will reach speeds of 12.5 ms^{-1} and could potentially injure or kill fish, birds and marine mammals (Wilson et al. 2007). The risk posed is poorly understood, because

little information exists on how animals utilise tidal habitats and there is a lack of any understanding of how marine mammals will react to turbine structures once deployed (Frid et al. 2012; Benjamins et al. 2015).

Several pieces of biological information are required for each species of concern to be able to predict collision risk. These include: the density of animals in the area of interest, their depth distribution and underwater movements and the extent to which they can detect and avoid the devices.

Methods for determining density are well established for most species, although some difficulties are introduced in tidal areas due to rough sea states, small site sizes and difficulties of surveying in fast moving currents (Gordon et al. 2011). The response of animals to turbines can only be effectively measured once the devices are deployed and operational, (although some experiments investigating behavioural responses to noise have been attempted pre turbine deployment (NERC/Defra RESPONSE project NE/J004251/1). The natural behaviour of marine mammals in tidal habitats, including their depth distribution and underwater movement, is very poorly understood. Traditionally these somewhat unusual areas have been poorly studied, in part because they are such physically challenging areas in which to work. This report focuses on the development of a practical and cost effective method to determine the underwater behaviour of harbour porpoises (*Phocoena phocoena L.*) and other echolocating cetaceans in tidal rapid habitats.

Harbour porpoises are the most commonly encountered marine mammal species in Northern European shelf waters (Hammond et al. 2013). They are listed under Annex II and IV of the EU Habitats Directive, which requires Member States to assess potential conservation threats, including industrial developments. Harbour porpoises are shy, elusive and difficult to detect visually in all but the calmest of sea states. However, like many toothed whales, they are highly vocal animals, producing characteristic very high frequency (130 kHz) echolocation clicks nearly continuously, both to sense their surroundings and hunt for prey (Dubrovskii et al. 1971; Mohl & Andersen 1973; Villadsgaard et al. 2007; Linnenschmidt et al. 2013). Transient sounds, such as harbour porpoise clicks, can be detected using hydrophones and high speed data acquisition systems (for a porpoise sampling at >300 kS/s) in conjunction with appropriate signal processing software (Madsen & Wahlberg 2007). The use of such methods to study animals is referred to as passive acoustic monitoring (PAM). PAM can complement and is often more effective than visual methods for detecting and studying harbour porpoises and crucially, for the application described here, PAM can be used to detect and localise the position of these cryptic animals in three dimensions underwater.

PAM methods have been employed to determine presence and density of harbour porpoises for decades (Chappell et al., 1996; Gillespie and Chappell, 2002). Multiple hydrophone elements

(hydrophone arrays) can be used to determine the position of animals underwater by measuring the time delay in receiving the same signal between different elements. Compact linear stereo hydrophone arrays are often towed behind survey vessels and can be used to calculate a distance to vocalising animals (Leaper et al. 2000). These can then be combined with concurrent visual observations allowing the absolute density of animals within an area to be determined (Leaper & Gordon 2012). However, towed stereo arrays do not provide sufficiently accurate data to determine animal movements in detail. Much larger arrays with a greater number of more widely spaced hydrophone elements can provide instantaneous 3D locations of vocalising animals. Such 'large aperture' arrays, which are generally deployed on the seabed *e.g.* (Roy et al. 2010; Wiggins et al. 2012) or from drifting vessels or buoys *e.g.* (Watkins & Schevill 1971; Heerfordt et al. 2007; Wahlberg 2002; Hastie et al. 2006; Miller & Dawson 2009), can provide more accurate information on animal locations, and in some cases, have been used to reconstruct three dimensional movements of animals underwater. Deploying such arrays in a tidal environment is difficult. Strong currents mean any seabed devices require large weights to remain stationary and acoustic sensitivity can be hampered by significant flow noise over hydrophones. Drifting systems are also problematic as the dynamically changing environment within tidal races systems can result in hydrophones moving in an unpredictable manner.

Since 2010, the Sea Mammal Research Unit (SMRU) has been developing large aperture hydrophone arrays and the associated software to track fine scale underwater movements of harbour porpoises and other echolocating cetaceans in tidal rapids, with an emphasis on providing information on animal diving behaviour for use in EIA (Environmental Impact Assessment) and collision risk assessment (Macaulay et al. 2015). This tracking system consists of a 30-45 m freely hanging vertical array and a small (~0.5 m) tetrahedral cluster of hydrophones deployed from a drifting vessel. The hydrophone array can drift through tidal rapids and determine the georeferenced positions of animals underwater, providing detailed information on underwater behaviour and, crucially, on depth distribution to help assess collision risk with tidal turbines.

Years of study and extensive calibration trials have shown this system is a powerful and cost effective methodology to assess harbour porpoise behaviour in tidal rapids. However, the requirement for a substantial vessel to drift through a tidal race means it is both expensive, sometimes dangerous to deploy in tidal rapids and requires a sizeable field team. Thus the final design of hydrophone array that emerged after many years of development was somewhat cumbersome, making it difficult for non-specialised research groups to utilise these methods. However, recent developments in digital acquisition and processing tools and further design refinements would enable us to recreate the functionality of the full system in a small, affordable buoy based format, which, in conjunction with streamlined, user friendly, open source software

would make the technology more widely available. The development of such a system forms the basis for this NERC Knowledge Exchange (KE) project.

In 2013, SMRU applied for and was awarded a knowledge exchange contract to package the drifting hydrophone array into an easy-to-use autonomous buoy capable of collecting the same quality of data. The advantages of such a system are numerous. A buoy is safer as it does not require a vessel to drift through tidal rapids. As such it can be deployed in rougher weather and is easier to use at night. It is also much smaller than a boat based vertical array and so can be deployed from a RHIB (Rigid Hull Inflatable Boat) or other small vessel, significantly reducing costs. Perhaps the greatest advantage is that an autonomous buoy is far easier to use and requires a much smaller specialist team to be present. Thus data collection is both less expensive and should be achievable by most marine environmental consultancies.

Our remit with the KE project was, to use readily available and off the shelf components in developing a cost effective accessible system supported by user friendly software. The main deliverable was to be detailed instructions on how to assemble the necessary hardware, including details of suppliers for components, the software and instructions on how to use it (these are provided in the two Appendices to this report).

This report focuses on an overview of the design of and methods to construct a Porpoise Locating Array Buoy (the PLABuoy). The buoy consists of a small waterproof enclosure (barrel) containing a communication and recording system attached to a 30m long flexible hydrophone array with a weight on the end to keep it steady in the water column. The weight and barrel are easily lifted by a human and the whole system can be deployed and recovered from a small outboard-powered vessel.

Open source software has been created to run on the PLABuoy embedded computer to enable acoustic data collection, wireless interaction with a tablet or computer whilst deployed and for post processing the collected data. Algorithms and new features have been added to PAMGuard (Gillespie et al. 2009) , a widely used, open-source, passive acoustic software suite, in order to facilitate data analysis. Details on how to set up the recording computer and electronics are discussed (in Appendix 2) along with setting up the development environment and downloading source code, allowing new features to be added or existing features to be improved.

Tidal races are harsh environments and equipment must reflect this. The report therefore also details how to cost effectively build robust hydrophones which can survive rough treatment during deployment and recovery from a small vessel. Another consequence of tidal races is the potential for flexible vertical arrays to bend substantially underwater, due to differential currents or wind against

tide effects. The use of IMU (Inertial Measurement Unit) sensors to track this movement, allowing the positions of hydrophones to be determined, is also described.

Finally, trials of the first prototype PLABuoy took place off Anglesey in Wales (April 2015). These demonstrated that the system was robust, practical to deploy and capable of providing accurate locations and tracks of calibration sound sources as well as harbour porpoises underwater. Results of these trials are presented.

2 Design Considerations

A report to the Scottish Government (Macaulay et al. 2015) detailed the various factors which must be considered when designing a large aperture hydrophone array that can be deployed in tidal rapids. These can be summarised as follows;

- The array must allow for quick deployment and recovery.
- Hydrophones must be spaced widely enough to allow for accurate localisation up to a few hundred meters from the array but close enough together that the narrow acoustic profile of a harbour porpoise bio-sonar consistently ensonifies multiple elements at once.
- The array must be capable of determining the 3D geo-referenced locations of harbour porpoises. As the main array was flexible and moved in the current, this required movement sensors and additional rigid tetrahedron hydrophone cluster to calculate headings to animals and remove ambiguities in predicted depth and range.

The final hydrophone array design, used to survey multiple tidal sites, therefore consisted of a 20-50m vertical array with 6-8 evenly spaced hydrophones and a small rigid cluster of four hydrophones attached to the directly to the aft of vessel. A vector GPS, inclinometer and IMU sensors on the array were used to model array movement and determine the real world positions of hydrophones which allowed georeferenced positions of harbour porpoises to be calculated. This system proved to be both accurate and capable of collecting large quantities of data on harbour porpoise behaviour in tidal races (see Macaulay et al. (2015) for details).

2.1 PLABuoy Array Design

In order to collect the same quality of data as a boat based vertical array the PLABuoy needed to be based on much the same design, *i.e.* a large linear vertical array and a tetrahedral cluster of hydrophones along with sensors to measure orientation of the array elements. The boat based system used a vector GPS to determine ultra-high accuracy heading, pitch and roll information of the research vessel and therefore of the rigidly attached tetrahedral hydrophone cluster. Cost and considerations of practicality meant that it was not possible for the PLABuoy to have an attached vector GPS and instead, the tetrahedral cluster was attached directly to the vertical array and its orientation measured by an IMU. GPS data were collected separately from a small GPS receiver, attached to the buoy. The

buoy based vertical array was much the same as in the boat based system except it used four hydrophones rather than six. Hydrophones were relatively evenly distributed along the length of the array and IMU units attached at regular intervals to measure movement. A diagram of the array is shown in Figure 1.

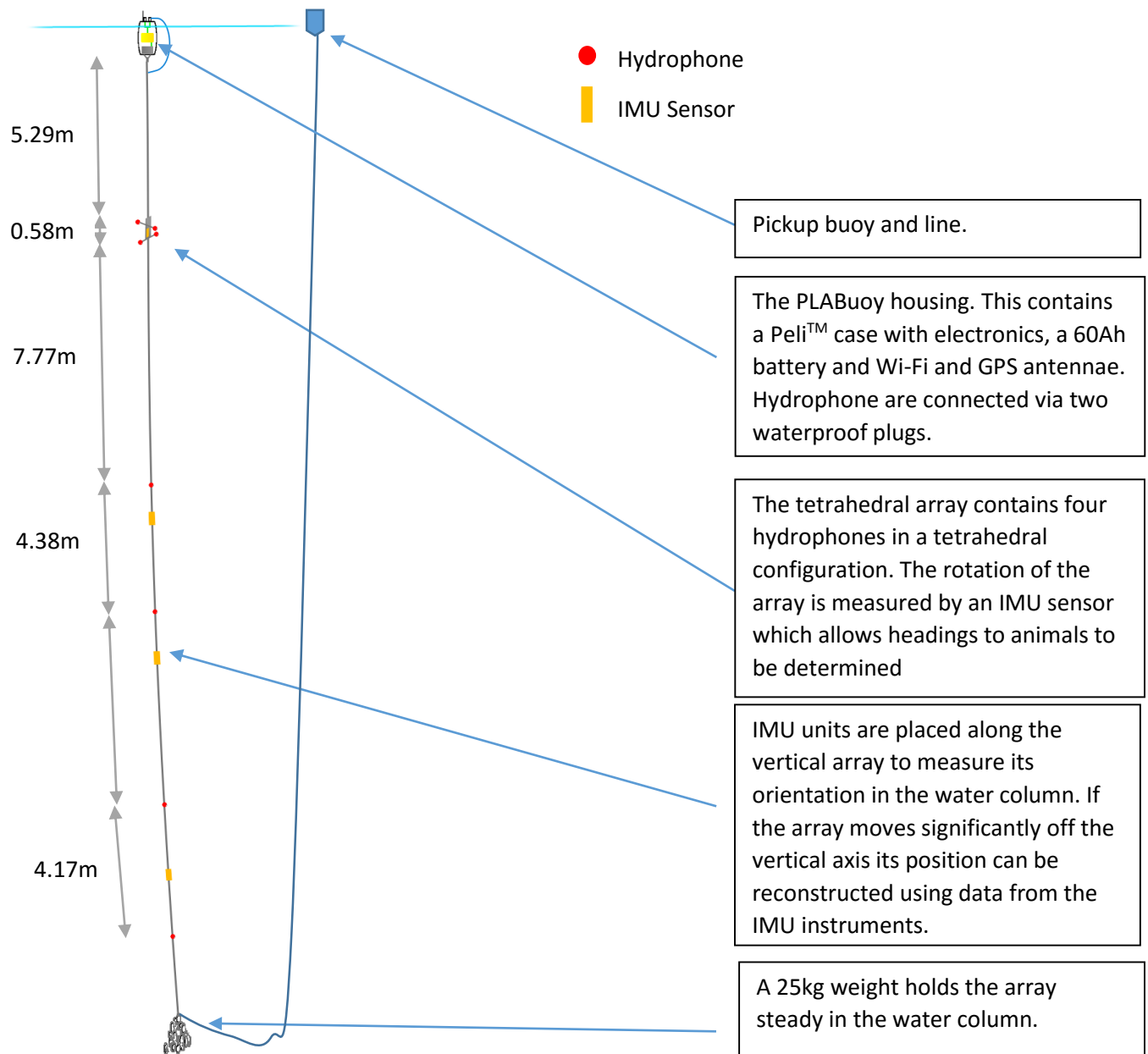

Figure 1. Scale diagram of the PLABuoy. A waterproof housing is connected to a weighted linear hydrophone array. The hydrophone also has a small rigid tetrahedral (cluster) array attached. Intuitively the linear section of the array can be thought of as providing the range and depth of the animals and small tetrahedral array a heading to the animal, providing a full three dimensional position.

2.2 PLABuoy Electronics

2.2.1 DAQ System

The boat based vertical array system required 3 amplifiers, 2-3 sound cards, a powerful laptop, GPS and several large 12V batteries to run. Such a system is power and space hungry and not suitable for

a low power autonomous buoy. A typical digital acquisition (DAQ) system requires three main components: an amplifier and filter unit, a data acquisition system and a computer. An amplifier amplifies the analogue signal received from the hydrophones, filters out low frequency noise and prevents aliasing. The sound card converts the analogue voltage received from the array into a digital format by sampling the signal at regular intervals; as harbour porpoise click is centred at about 120-145 kHz (Mohl & Andersen 1973; Dubrovskii et al. 1971; Villadsgaard et al. 2007) the Nyquist frequency is around 300 kS/s; a standard sample rate typically used is about 500 kS/s per channel. A computer is needed to read and save the data received from the sound card in a suitable format and for general communication and control.

A sample rate of 500 kS/s on eight individual channels equates to 4 million accurate measurements per second. As far as we are aware there is no off-the-shelf PAM dedicated system which is capable of recording at that data rate. Several companies, *e.g.* National Instruments, SAIL (St Andrews Instrumentation Limited) and Measurement Computing™ produce data acquisition devices which can sample >8 channels at 500 kS/s however the drivers supplied are generally either for computers running a Windows operating system or exclusively for x86 processors. Windows and desktop Linux distributions are too complex and unstable operating systems which are not well suited to the simple task of recording and saving data and x86 processors are generally power hungry (although recent advances by Intel in particular have significantly reduced power consumption). Table 1 summarises three options which were considered.

Table 1. The different options considered for the PLABuoy DAQ system.

Name	2 SAIL DAQ cards and x86 computer	National Instruments USB card, amplifier and x86 computer	cRio and amplifier
DAQ card	SAIL DAQ card	National Instruments USB 6356	2 X NI9222
Amplifier	SAIL DAQ card (integrated amplifier and filter)	ETEC custom made amplifier and filter	ETEC custom made amplifier and filter
Computer	Lower power x86 (Windows or Linux) ARM drivers not available	Lower power x86 (Windows) ARM and Linux drivers not available	cRio 9068.
Data Acquisition Software	PAMGUARD	PAMGUARD	PLABuoyC

Reliability	Poor if using Windows or OK if using lightweight Linux OS DAQ cards untested at time.	Poor due to using Windows. DAQ cards tested and generally very reliable	High due to industrial embedded computer and lightweight OS.
Power Consumption	High	High	Low
Development time	Low	Low	High

The option based on a cRio from National Instruments was chosen as it provided the best balance between reliability, development time, using open source software and keeping power consumption low. The cRio is essentially a low power embedded computer with an ARM-based processor running a custom version of Linux. The actual computer contains a powerful dual core ARM Cortex-A9 processor and an Artix-7 FPGA which can be programmed in LabView, a graphical programming language that is relatively easy for users to learn and use. Although the FPGA requires LabView, a proprietary programming language, the rest of the system is highly flexible, with users able to create programs in multiple open source languages. The typical user should not need to write any additional programs however so an investment in LabView will not generally be necessary. National Instruments provide good support for C and C++ with an easy to use library which can communicate with the FPGA and external NI DAQ systems. The cRio hardware is designed to be modular and a range of different plug in modules can be added to the system. We used two NI9222 DAQ modules, each capable of sampling 4 channels at 500kS/s. Compact, low powered, multi-channel amplifiers which work at harbour porpoise frequencies are difficult to source and so we commissioned ETEC to design and build a small 10 channel amplifier and filtering system with adjustable gain and filter settings. The cRio with NI 9222 modules and the ETEC amplifier thus formed the core of the PLABuoy data acquisition system.

Peripheral instruments included a serial GlobalSat BR-355-S4 GPS directly connected to the cRio serial port to record positions, an ALFA AP121U wireless router connected to the cRio Ethernet port to allow for wireless communication and a Samsung Evo 500GB external solid state hard drive to save digitised sound and other data. We chose to use a solid state hard drive because it had lower power requirement a higher data rate and was more resilient to movements and knocks than a

spinning hard drive. A summary diagram of the electronics is shown in Figure 2.

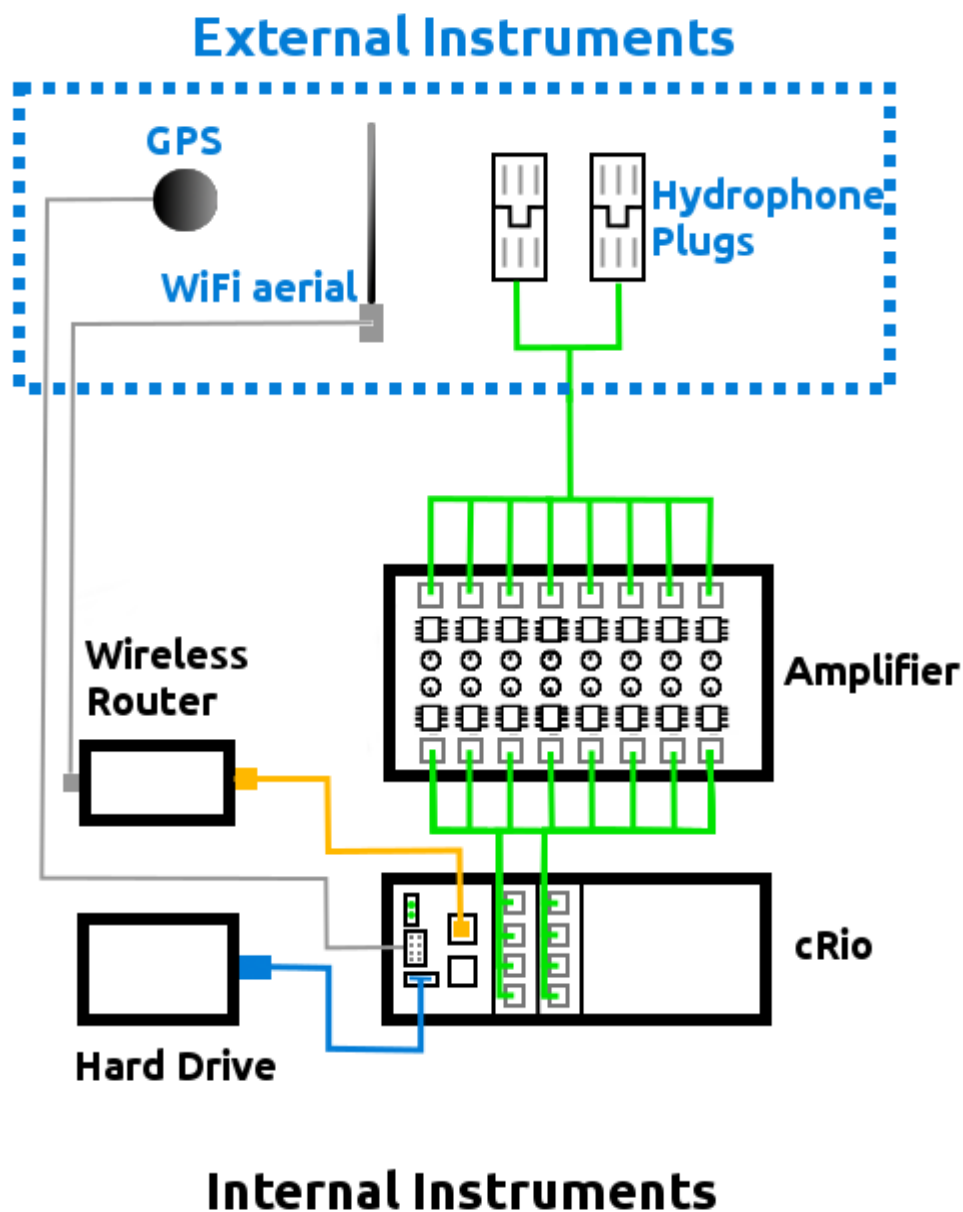

Figure 2. Diagram of PLABuoy electronics. Hydrophones signals are amplified and filtered by a custom 8 channel amplifier. The filtered and amplified signal is then digitised and saved by the cRio. GPS data is also saved to the hard drive and a wireless router allows external users to communicate with the cRio using a smartphone, tablet or laptop.

2.2.2 IMU units

IMU units are required to measure the orientation of the tetrahedral array and to measure the angle of the flexible vertical component of the array. We chose to use 1st generation OpenTag™ units from LoggerHead Instruments. These are open hardware and software IMU units with a 3D magnetometer, accelerometer and gyroscopes. They also include temperature and pressure sensors and record all data to an internal micro SD card. It would have been ideal to have IMU units which were recorded directly by the cRio, however this would have been less flexible and would require

more complex cables and could have introduced electrical noise. OpenTags™ have an associated MATLAB library to extract raw measurements and calculate 3D orientations, however we also designed our own custom Java library with a more user friendly interface.

2.3 PLABuoy Housing

One of the main engineering challenges in creating a marine autonomous data acquisition system is safely placing sensitive electronics into a highly conductive and corrosive liquid (sea water).

Hydrophones, a Wi-Fi aerial and GPS, must be connected to the DAQ system without compromising the integrity of any waterproof housing.

Our approach involved using two waterproof housings. The cRio, amplifier, Wi-Fi router and hard drive were placed inside a small Peli™ Storm iM2100 case and this Peli case plus a 12 V battery were themselves placed inside a waterproof drum. The lid of the drum was fitted with waterproof 900 Series Buccaneer 10 pole connectors to connect to the vertical hydrophone array. A waterproof GPS and Wi-Fi aerial were brought through additional waterproof glands. The Peli case was placed inside the drum and connected directly and permanently to the hydrophone plugs, GPS and Wi-Fi aerial on the drum lid. Cable glands provided a waterproof entry for wires entering the case. This two tiered protection proved relatively robust, with the PLABuoy suffering several full submersions in a tidal race after snagging the bottom. It was not, however, indestructible. At the end of our final survey in Kyle Rhea the PLABuoy snagged in the tidal narrows and suffered a 4-hour immersion at 10-20 m. Two hours into the immersion the waterproof drum imploded and the Peli case glands failed, probably due to the water pressure at these depths.

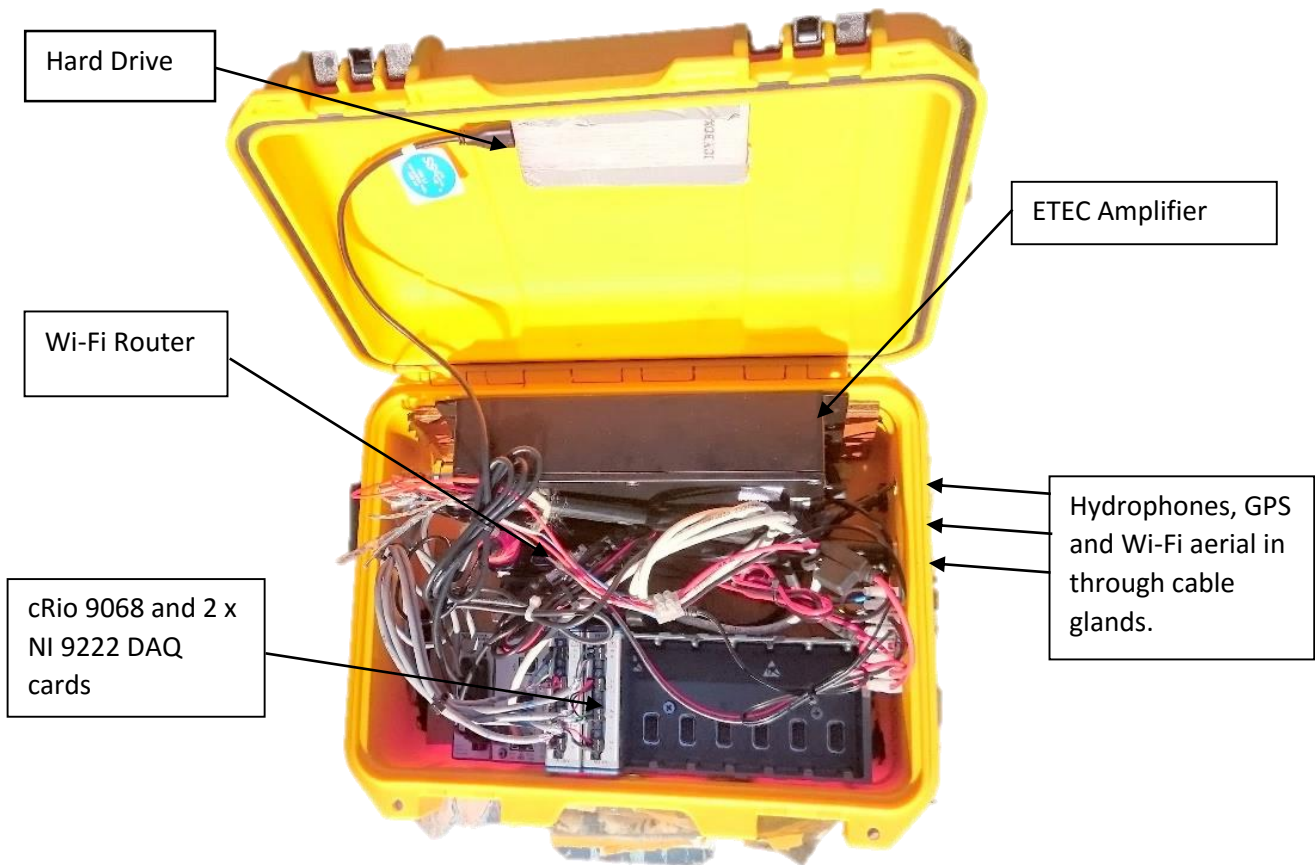

Figure 3. Picture of the Peli™ case which contains the PLABuoy data acquisition system. The cRio records 8 channels @ 500 kS/s and logs GPS data. The ETEC amplifier was set to amplify the incoming signal by 14dB, filter any signals below 10kHz and prevent aliasing.

2.4 Hydrophone Array

Hydrophones are one of the most delicate components of any PAM systems. These can easily be destroyed on a vessel, for example by someone stepping on an exposed element. As the PLABuoy was to be deployed from a small vessel often in rough conditions, it was essential to construct the hydrophone array so it could withstand the inevitable knocks associated with working on a boat, hitting the seabed in strong tidal currents and continuous deployment/recovery over a period of weeks. Hydrophones and their associated pre amps were therefore placed inside acoustically transparent oil filled polyurethane tubes as shown in Figure 4 . These casings proved sufficient to protect hydrophones and amplifiers from the usual inevitable accidents in the field and no

hydrophone elements were lost during any of the field trials.



Figure 4. Picture of a ruggedised hydrophone and pre-amplifier. Each hydrophone and pre-amplifier were placed inside a flexible oil filled polyurethane tube. These prevented hydrophone elements being accidentally destroyed in the field.

Comprehensive details on constructing both the PLABuoy housing and hydrophone array can be found in the Appendix 1.

3 PLABuoy Software

Three open source programs have been created for the PLABuoy; these are *PLABuoyC*, *PLABuoyHydrophones*, *PLABuoyInterface*.

PLABuoyC is a C++ program which runs on the cRio. It handles communication with the DAQ cards and wireless router and saves recorded data to the hard drive. The program is modular in design which means it can be easily expanded in future if additional functionality is required, for example the implementation of a real time cetacean click detector or long term spectral average calculation. Currently modules exist to acquire data from the NI 9222 DAQ cards, send real time data through Ethernet, save GPS or serial data and save recordings as raw .wav files or compressed X3 files (Johnson et al. 2013)

The Wi-Fi router on the PLABuoy enables the user to use *PLABuoyInterface* to wirelessly check status of the buoy from ranges up to around ~200m. **PLABuoyInterface** is a JavaFX program which can be used to communicate with the PLABuoy through a Wi-Fi network. This allows users to start and stop the buoy, check real time level meters and assess how full the hard drive is (Figure 5).

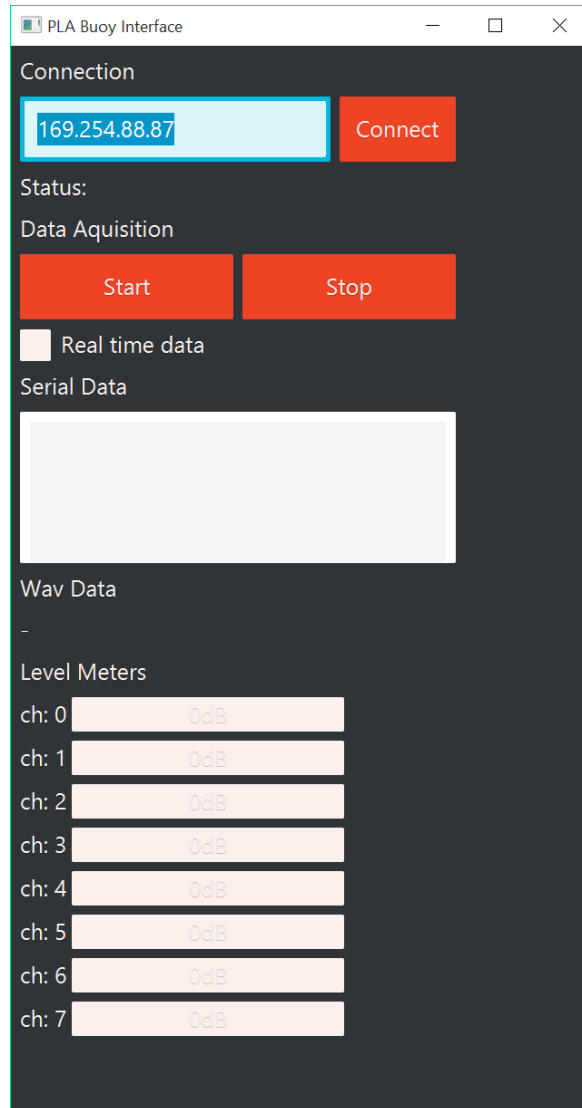

Figure 5. PLABuoy Interface is an application to allow users to control the PLABuoy over a wireless network.

PLABuoyHydrophones is an easy to use JavaFX program which enables users to load data from external sensors to model the positions of hydrophones on a moving array (Figure 6). IMU Open Tag and GPS data from the PLABuoy can be loaded and the movement of the array visualised in 3D and then batch processed into files which can be loaded into PAMGUARD, an open source analysis suite for PAM data. This greatly simplifies one of the most complex analysis steps required when flexible drifting arrays such as the PLABuoy are used. *(Note: PLABuoyHydrophones is still in early Alpha testing)*

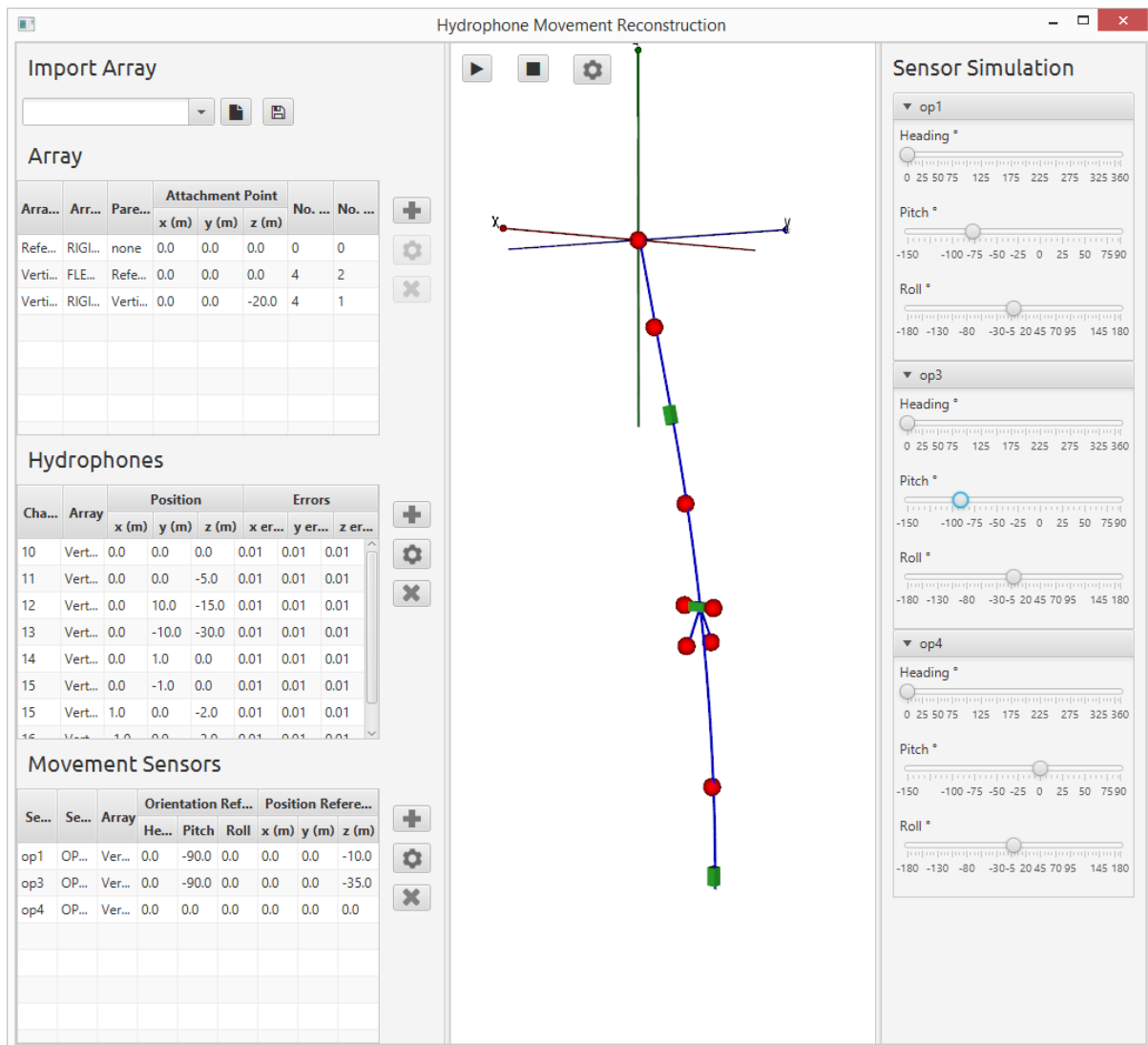

Figure 6. Array modelling software, 'PLABuoyHydrophones'. This can be used to model the position of hydrophones if the vertical array moves substantially underwater. The output time series of hydrophones can be imported into PAMGuard software.

4 Data Collection

Using the PLABuoy in the field is relatively simple. The user powers up the cRio by connecting the battery. A green LED on the cRio indicates that pre checks are complete and the PLABuoyC program is running. Users can either set PLABuoyC to start recording immediately when the cRio is turned on, in which case another green LED will become visible, or start when a signal is sent from a tablet or laptop running the *PLABuoyInterface* program.

All of the OpenTags are then switched on and each is tapped against one of the hydrophones on the array. The taps will be registered on both the gyroscope of the OpenTag and hydrophone of the array which allows the OpenTag and DAQ clocks to be accurately synchronised in post processing.

The Open Tags are then attached to the array. The recorder can be turned off during attachment by using the PLABuoyInterface or simply cutting power to the device.

The Peli case and lid of the barrel are sealed, the hydrophone array is attached to the barrel and both plugs connected. The PLABuoy is then ready for deployment. This usually involves one person lowering the hydrophone array with a 10- 25kg weight on the end and another ensuring that nothing gets snagged or tangled (Figure 7). Once the hydrophones are in the water, the PLABuoy housing can be dropped over the side. Deployment is now complete and users can start the device recording using a tablet or laptop running *PLABuoyInterface* software.

The buoy is left to drift until recovery. With the 60 Ah 12 V battery used here, the buoy should be capable of running continuously for at least two days. However due to the substantial currents and hence distances the PLABuoy can drift, in many tidal races drifts it was usual to recover the buoy after about 2 hours and reset it up current. At the end of the final drift the OpenTags are again tapped against the hydrophone array to allow measurement of clock drift. The PLABuoy is then powered down and the hard drive removed (usually ashore in a safe dry location). The data on the

hard drive and OpenTags are then backed up.



Figure 7. Deploying the PLABuoy. One person (red coat) lowers the weight on a rope. The other flakes out the cable and hydrophones. Once everything is in the water the weight transfers to the hydrophone array allowing it to remain vertical in the water.

Note that in order to make sure the buoy could be found if visual contact was lost a SPOT Gen 3 satellite tracker was attached to a short “mast”. A Holux M-1000C GPS logger was also add as a backup in case the main GPS failed.

5 Data Analysis

Analysis of data from drifting hydrophone array is necessarily involved. However, progress has been made in turning development code in MATLAB (The Mathworks Inc.) and Java into a series of easy to use open source programs detailed in section 3.

5.1 Modelling Array Movement

The first step in the analysis is to model the movement of the array. Data from the OpenTag IMU sensors and a GPS are used to model movement of the array underwater and determine real world positions of hydrophones at frequent time intervals (typically 0.25 secs). The process of converting raw data collecting on IMU sensors and the GPS into hydrophone positions is not trivial. Details of the algorithm we used to model the array movement are discussed in (Macaulay et al. 2015) and have been integrated into the *PLABuoyHydrophone* software which provides an easy to use interface to load sensor data and model hydrophone positions. (In addition OpenTags are supplied with a library in MATLAB allowing users to create custom scripts to determine hydrophone positions if they so wish). Appendix 2 contains a walk-through guide to field procedures to ensure that the IMU sensors are accurately calibrated and provides instruction on how to use the *PLABuoyHydrophone* program. An example of the degree of movement of the PLABuoy array is shown in Figure 8.

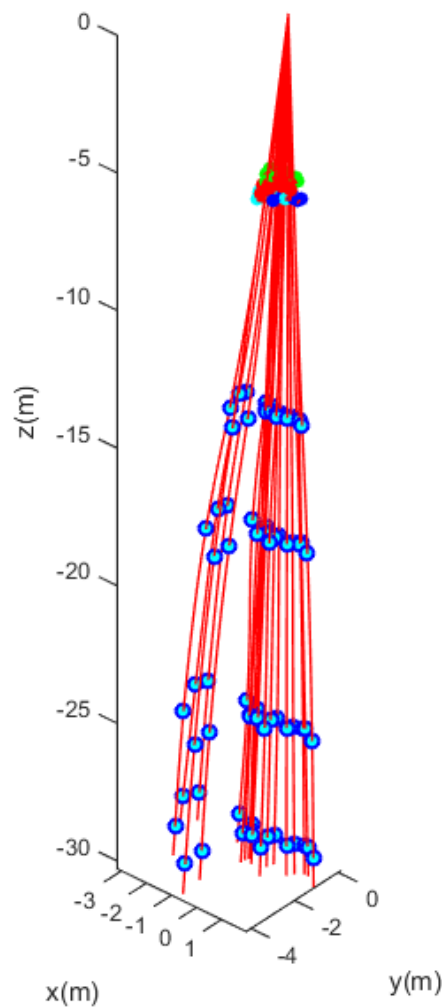

Figure 8. Movement of the PLABuoy over a 14 minute period. In areas within the tidal stream the array remains relatively vertical but at other time it can move substantially off the vertical axis.

5.2 Analysis in PAMGUARD

Once the positions of hydrophones have been determined by modelling array movement the acoustic data can be analysed.

PAMGuard contains an automatic click detector and localiser, capable of quickly analysing data from moving and widely separated hydrophone arrays. It is most effective to use this in a supervised mode with an experienced analyst checking and validating detections and click train bearings. The first stage in analysis is to isolate porpoise vocalisations from raw acoustic data. The PAMGuard click detector can be set to detect transient sounds in the porpoise frequency band and then classify every detection either being a porpoise click or not (Figure 9). As with any detection algorithm, there is a trade-off between detecting every true vocalisations and the number of false classifications. We chose slightly more sensitive classification settings in order to minimise the number of vocalisations missed. This is appropriate as false classifications can be dealt with by the localisation algorithms

used in a later analysis stage, whilst false negatives are excluded from further analysis.

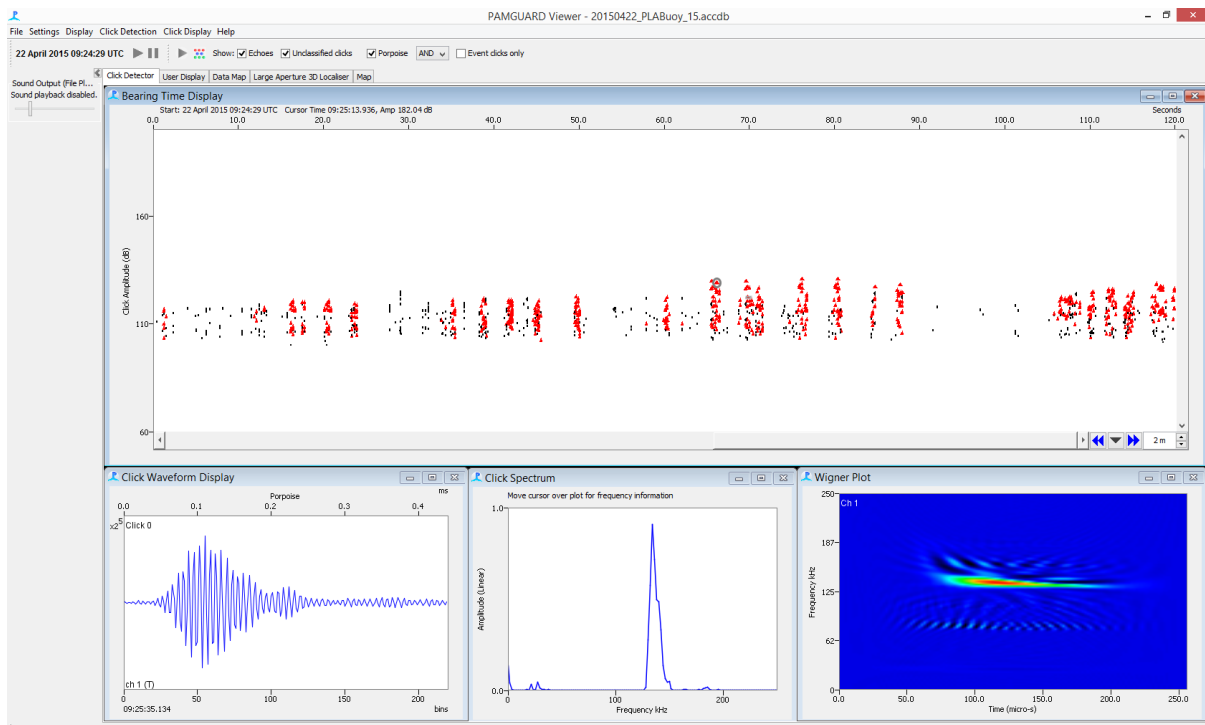

Figure 9. Porpoise clicks detected on the PLABuoy and displayed in the PAMGuard click detector.

Once all the clicks have been detected, data are passed to the PAMGuard Large Aperture Localisation Module (Figure 10). This module works by detecting a click on a single hydrophone and attempting to find the same click on all other hydrophones. Echoes, other vocalising animals and rapid vocalisation rates can confound such click-matching and hence the localiser utilises a ‘detection match’ algorithm to determine the correct combination of clicks between hydrophones. This discards echoes and false detections on other hydrophones and allows the localiser to track multiple animals simultaneously. See Macaulay et al. (2015) for details.

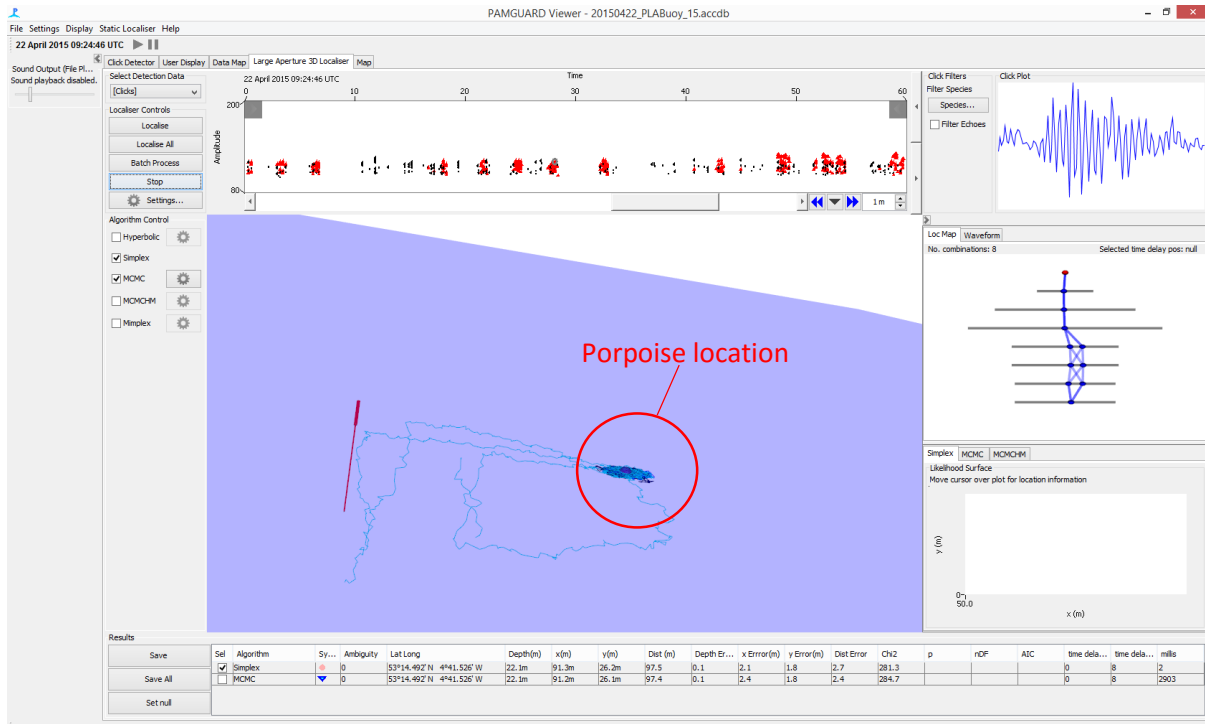

Figure 10. The PAMGuard large aperture localiser. Multiple localisation algorithms can be used to locate animals. The display on the right shows the possible combinations of click detections between different hydrophones on the array.

After localisation is complete, results are stored in a PAMGuard database and/or .csv spreadsheets. Although the detection match algorithm does a good job at finding the correct combination of clicks between hydrophones it can still make mistakes by matching clicks with echoes or other spurious noises. The final stage of analysis is therefore to filter results. Some errors can be removed fairly simply, e.g. by removing localization results which are above or below the seabed. In addition results can be filtered if the fit to the localisation algorithm (the X^2 value) falls below a certain threshold. The best way to set this threshold is for an analyst to examine data from calibration trials and set a value for X^2 which provides a good balance between removing spurious and keeping correct results.

6 Field Tests

We field tested the PLABuoy in two locations proposed as sites for in-stream tidal turbines; Kyle Rhea Scotland and West Anglesey Demonstration zone in Wales, both have been proposed as sites for the deployment of tidal turbines. Initial trials in Kyle Rhea simply involved testing the reliability of the PLABuoy and how well it performed in conditions within a tidal stream. In West Anglesey, calibration trials were conducted to assess how accurately the buoy could localise the position of a sound source producing porpoise like clicks at a known location and depth.

6.1 Tests of Accuracy

The accuracy of the PLABuoy was explored by broadcasting simulated porpoise clicks at known positions and depths. A MATLAB script was written to produce a single channel WAV file containing

bursts of 25 simulated porpoise clicks. This was output through an NI 6252 DAQ card at 5V peak to peak using PAMGuard. The signal was amplified by a powerful Sony XPLOD 1200x car stereo amplifier and then projected from a transmit transducer, a Neptune Sonar HS150 hydrophone (Neptune Sonar Ltd.), on a 30 m cable from a survey vessel. An Aladdin dive computer and an Open Tag were used to record the depth of the transmit hydrophone and a GPS logged the location of the survey vessel carrying the sound source every 5 seconds

The data collected on the PLABuoy were analysed in PAMGuard and MATLAB using methods described in section 5. The localised positions of pings was then compared to the true locations of the sound source and errors were calculated

6.2 Results

Localised results were compared to the true range and depth of the pinger system and average error calculated. Figure 11 and Figure 12 show the true depth and position of the pinger with the localisation results from the PLABuoy overlaid. Figure 14 and Figure 15 summarise this by displaying the error between the broadcast pinger depth and range and localised depth and ranges in 20m range bins.

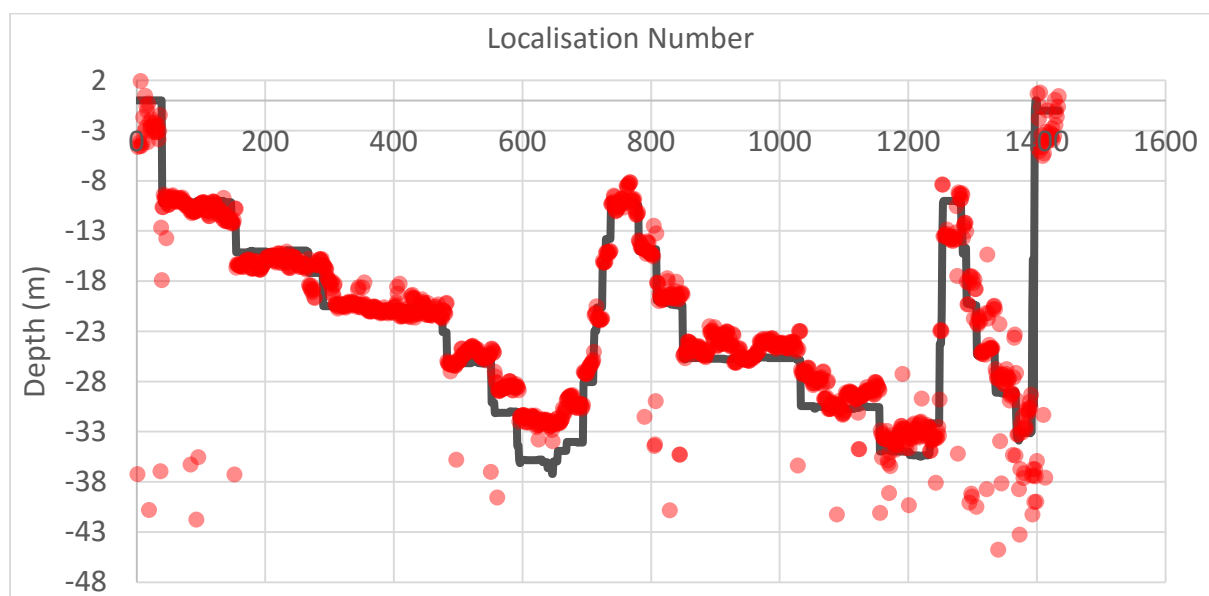

Figure 11. An example of raw localisations from the calibration trials. The grey line is the depth of the playback device and red dots are locations of playback pings localised by the PLABuoy.

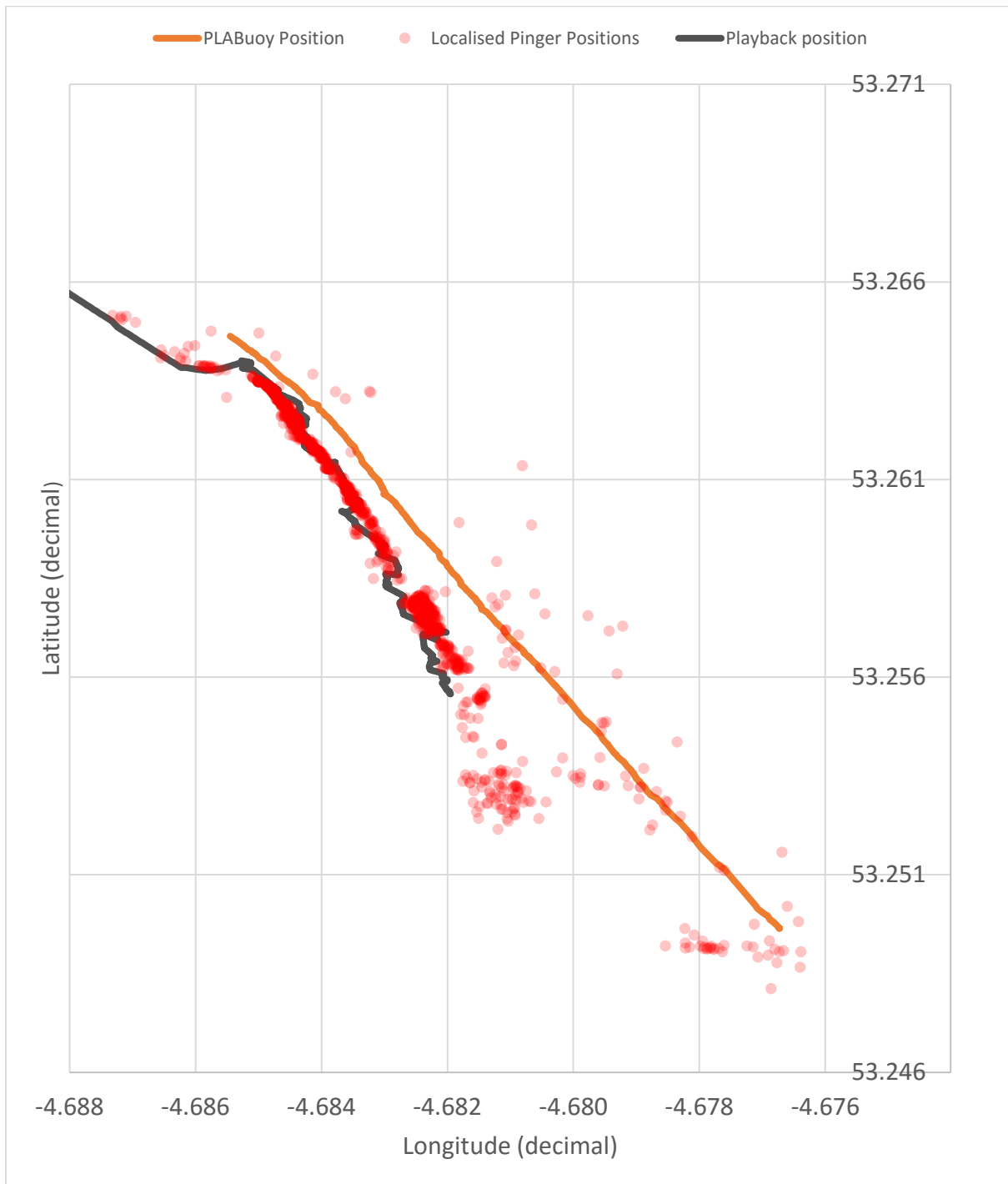

Figure 12. The position of the PLABuoy and playback device with overlaid localisations. The grey line is the position of the boat producing simulated porpoise clicks. The orange line is the position of the PLABuoy. Red dots are localised positions.

6.2.1 Calibration Trials with Array Movement Modelling

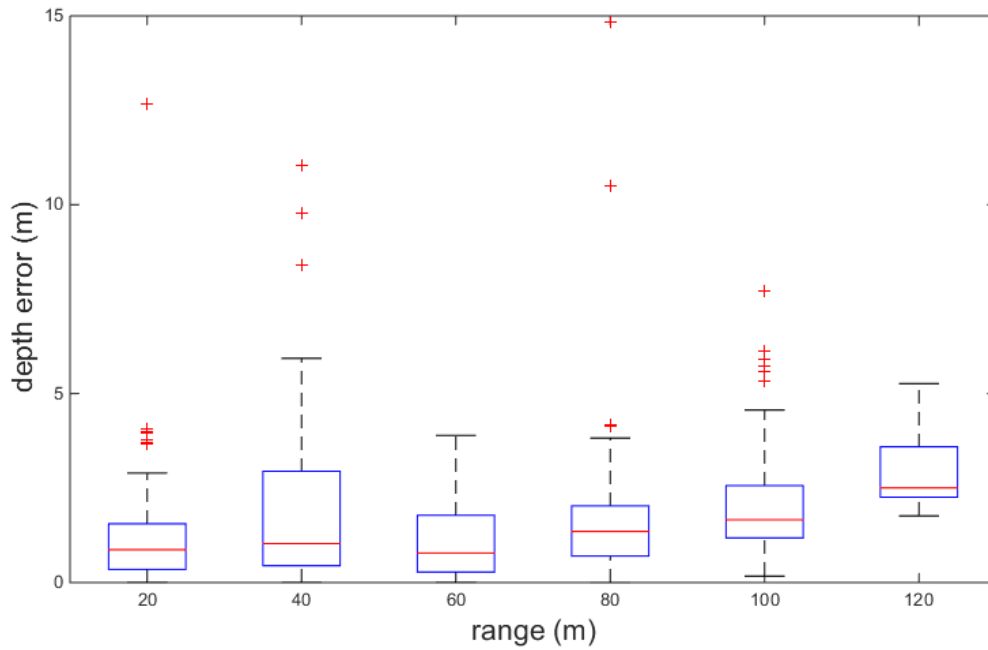

Figure 13. Depth error versus the true range from the porpoise playback device to the array.

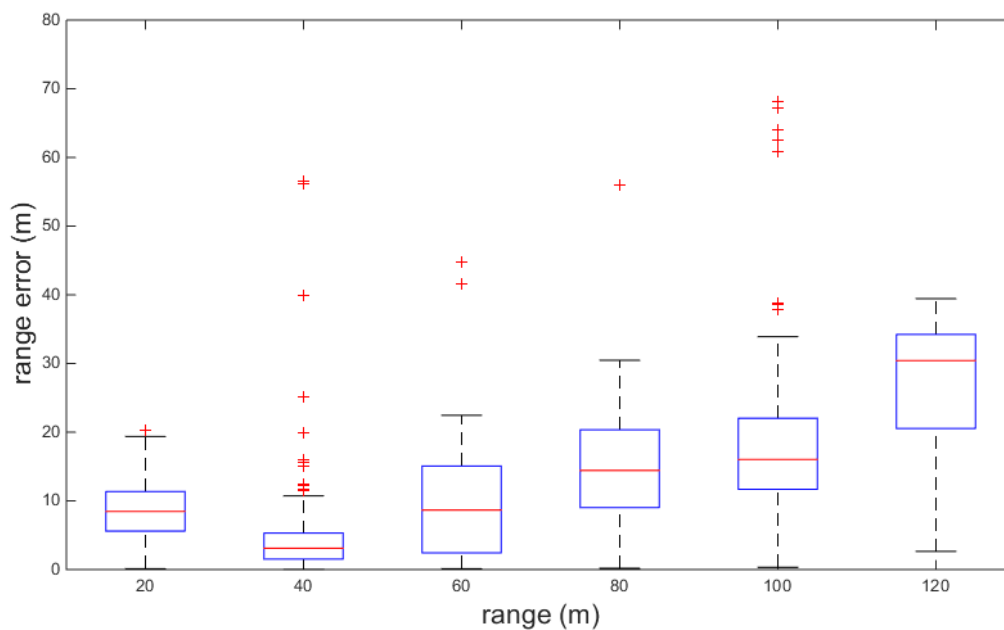

Figure 14. Range error versus true range from the porpoise playback device to the array.

6.2.2 Accuracy Compared to Boat Based System

The calibration trials from the PLABuoy were compared to calibration trials from the boat based array used in Macaulay et al. (2015). Figure 15, Figure 16 and Figure 17 compares errors in depth, range and heading to the simulated source for the boat based systems and the PLABuoy. It should be noted that these trials took place in different locations and the boat based calibration used a louder calibration source, which could be detected at greater ranges and produced a greater signal to noise

ratio. In addition, the boat based calibrations were more extensive with ~18000 data points compared to ~2000 for the PLABuoy.

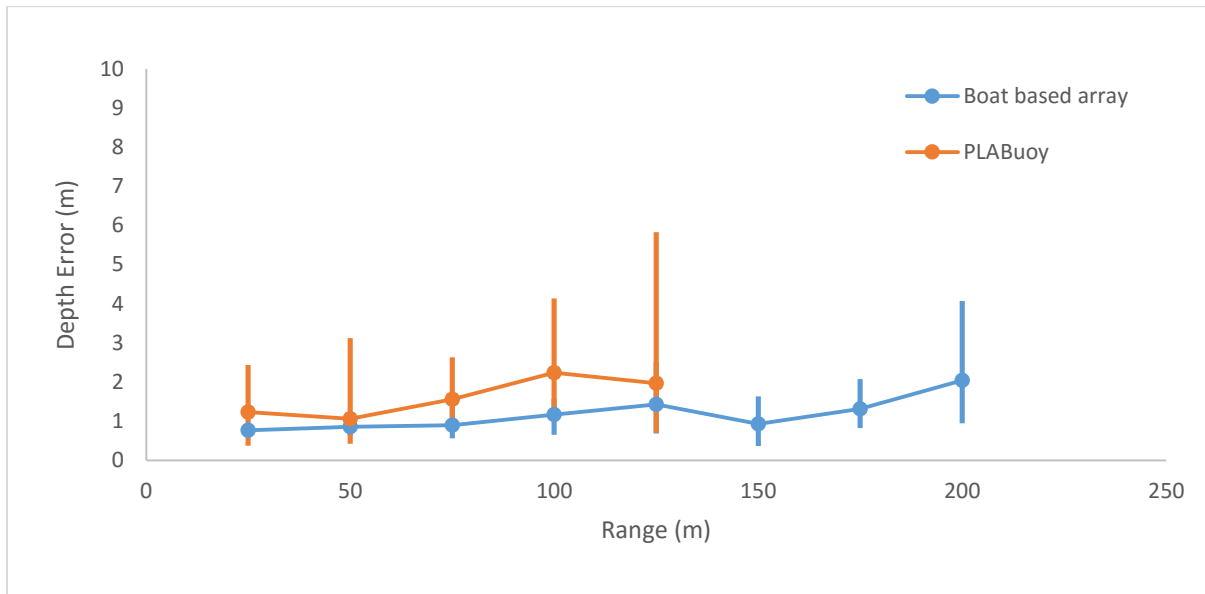

Figure 15. Error in depth localisation for the PLABuoy and the boat based array. The PLABuoy is less accurate, however maintains an average depth error below 2m up to up to 125m range.

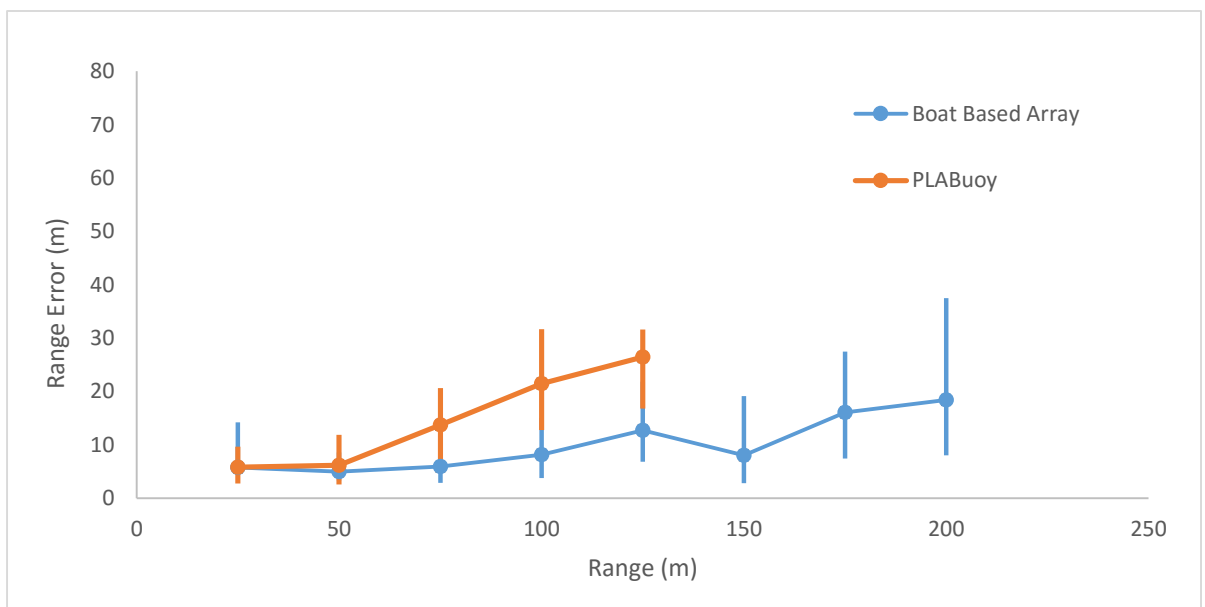

Figure 16. Comparison of error in range localisation for the PLABuoy and boat based array.



Figure 17. Comparison of error in angle to the pinger for the boat based system and the PLABuoy. In order to minimise errors from GPS systems only ranges >40m were used in angle calculations.

6.3 Porpoise Dive Profiles

Porpoise dive locations were calculated using the localisation methods used to localise the position of simulated clicks. An example of porpoise dive tracks off the Anglesey coast, Wales and associated bathymetry data is shown in Figure 18.

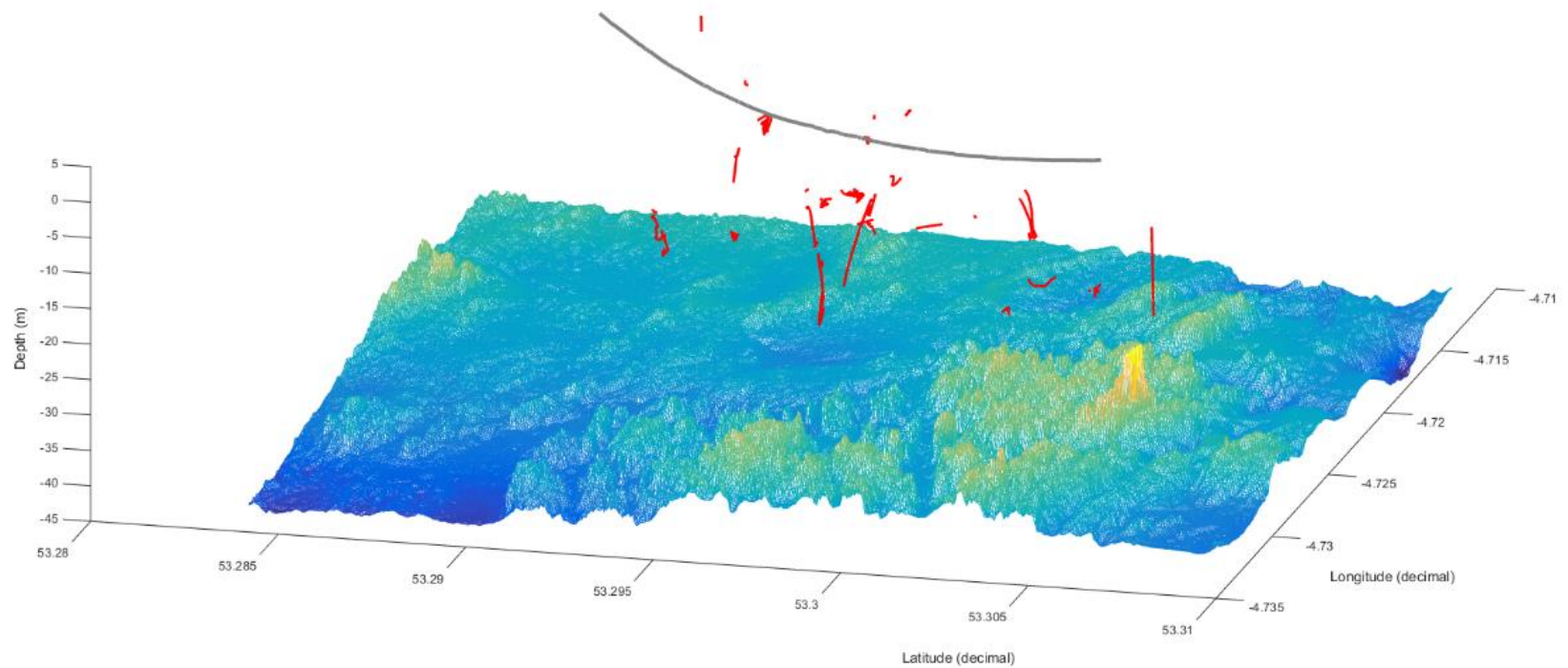

Figure 18. Dive fragments of porpoise dive tracks. Red lines are porpoise dive fragments, the grey line is the GPS track of the buoy and the surface is the seabed (Bennell et al. See section 8.1 for full reference). Data was collected on the PLABuoy and processed in PAMGuard to determine positions of porpoise vocalisations. These data were passed through a multi-track Kalman filter to create track fragments of animals. Note that we refer to track fragments as an animal's narrow beam profile means it does not continuously ensoufy the hydrophone array during a dive.

7 Discussion and Conclusion

Results from initial calibration trials have been encouraging, showing that the PLABuoy, like the boat based system is capable of accurately localising the 3D positions of harbour porpoises. It was expected that some precision would be lost due to the reduction in the number of hydrophones, from 12 to 8, and switch from vector GPS to an IMU unit to determine the orientation of the tetrahedral hydrophone cluster. This was indeed the case with the PLABuoy producing more stochastic and less accurate localisation data than would be expected from the boat based vertical array. The larger variation in heading accuracy may in part be due to the fact the OpenTag on the tetrahedral array used magnetometer sensors rather than a vector GPS system. Improving the algorithms which model the orientation of the OpenTag and/or using a more accurate IMU system may be one way to improve accuracy in future.

The calibration trial took place in a relatively calm tidal area and low sea state. If time and weather had permitted, it would have been useful to conduct a calibration trial in both rougher conditions and a faster current in order to determine whether this would have a significant effect on accuracy. In addition, as a result of equipment malfunction, the pinger system used has a much lower output level than the equivalent system used to test our boat based survey. Thus calibrations were not possible at ranges greater than 125m and the signal to noise level was significantly worse, which could negatively affect localisation accuracy. Using a louder output system and performing more extensive calibration trials in a variety of conditions should thus be a focus of future work.

The measured errors in the PLABuoy system are well within the limits required to gain good quality information on harbour porpoise dive and underwater movement behaviour. They show that the PLABuoy is capable of determining the 3D geo referenced positions of animals and is therefore an effective tool for improving collision risk assessment.

In both Kyle Rhea and Anglesey the PLABuoy successfully detected and localised harbour porpoises. The detection of clicks on multiple hydrophone elements only occurs if a porpoise is orientated roughly towards the array. If facing away from the array, the narrow beam profile means that it is highly unlikely that a porpoise will be detected on multiple elements except at very close ranges. Therefore, instead of tracking an animal throughout its entire dive, acoustic data usually consist of fragments of dive tracks *i.e.* those times at which a porpoise is orientated so that its echo location clicks are detected on multiple hydrophone elements. Although recreated dive tracks are therefore fragmented, the potential volume of data collected (thousands of track fragments) means that a

statistical description overall behaviours of many individuals utilising tidal habitats can be determined.

The PLABuoy provides a low-cost practical hydrophone array for use in tidal rapids. The array configuration is relatively complex and simpler and less expensive configurations could also be used if full 3D geo-referenced locations are not required. One of the fundamental questions for developers of tidal turbines is the proportion of animals that may be in a danger zone, *i.e.* the area swept out by turbine blades. Although accurate animal tracks provide this information, location data which simply determines whether an animal is above or below a certain depth might also be suitable in some situations. A much less complex hydrophone array could provide such information and simplify analysis. Figure 19 and Table 2 detail some possible array designs and the information they provide. A feature of all of these arrays is that they utilise closely spaced 'clusters' of hydrophones. Rigid clusters have the great advantage of having a fixed spacing between hydrophones, reducing the need for modelling hydrophone positions as in the current PLABuoy system, although information on the orientation of the each cluster is still required.

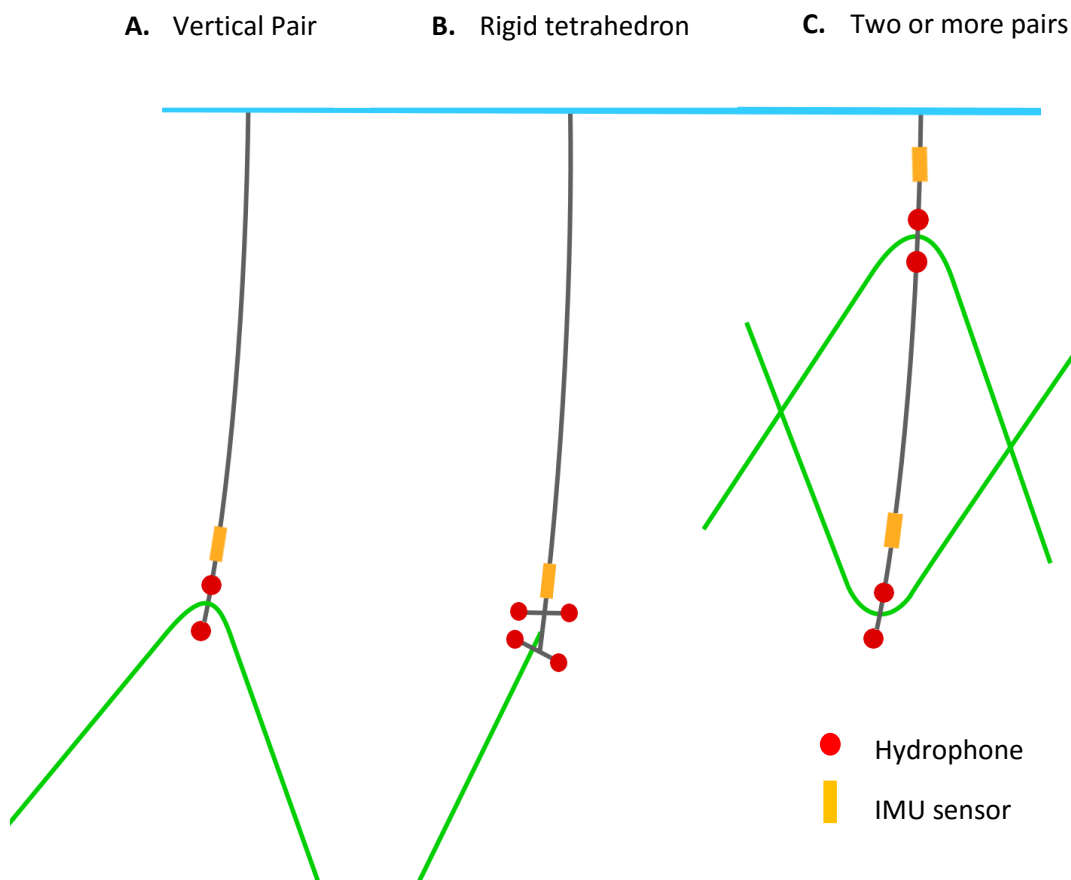

Figure 19. Diagram of alternate PLABuoy configurations. These configurations would simplify analysis, however provide less detailed information than the PLABuoy system described here. They may be useful in some site specific area, e.g. when only information the occurrence of animals above or below a certain depth is required. Green lines represent 2D localisation information which can be collected from each device.

Table 2. Details of the location information each alternate PLABuoy configuration could provide.

	A. Vertical Pair	B. Rigid Tetrahedron	C. Pairs
Description	Closely spaced pair of hydrophone orientated vertically. It is possible to determine whether an animal is above or below the pair and the vertical angle.	Closed spaced tetrahedron of hydrophone distributed in 3D. Can also provide a horizontal bearing to an animal.	Two or more pairs. It is possible to determine whether animals are above or below each pair and depth/range localisation possible, although less accurate than PLABuoy. See (Gordon et al. 2011)
No. hydrophones	2	4	4+
Above or below hydrophones	Yes	Yes	Yes
Depth of animal	No	No	Yes
Range of animal	No	No	Yes
Bearing to animal	No	Yes	No
Geo referenced position	No	No	No

With the exception of the amplifier, the internal electronics of the PLABuoy are standard ‘off the shelf’ items which are both easy to source and should be supported for the foreseeable future. The amplifier was designed specifically for this project by ETEC, a specialist electronics company in Denmark. They can readily build additional units to the same design.

It is hoped that this development will represent the first generation prototype and that other institutions and/or consultancies will improve the design and the open source programs which we have been created during the course of this project. All of our code to run the PLABuoy is in open access repository, and analysis algorithms have been added to the PAMGuard project which also has source code in an open source repository.

As the tidal turbine industry expands, quantifying depth distribution and underwater behaviour of animals at particular sites of interest should form a key part of any environmental impact

assessment. Our experience so far has been that the underwater behaviour and depth distributions of porpoises vary between sites so that underwater movement data need to be collected on a site by site basis. The PLABuoy opens the way to create a system for industry and researchers which is both easy to use in the field and can provide detailed information on animal behaviour.

8 References

- Benjamins, S. et al., 2015. Confusion Reigns? A Review of Marine Megafauna Interactions with Tidal-Stream Environments. *Oceanography and Marine Biology: An Annual Review*, 53, pp.1–54.
- Dubrovskii, N.A., Krasnov, P.S. & Titov, A.A., 1971. On the emission of echo-location signals by the Azov Sea harbour porpoise. *Soviet Physics-Acoustics*, 16(4), pp.444–447.
- Frid, C. et al., 2012. The environmental interactions of tidal and wave energy generation devices. *Environmental Impact Assessment Review*, 32(1), pp.133–139.
- Gillespie, D. et al., 2009. PAMGUARD: Semiautomated, open source software for real-time acoustic detection and localisation of cetaceans. *Proceedings of the Institute of Acoustics*, 30, p.2547.
- Gordon, J. et al., 2011. Assessment of risk to marine mammals from underwater marine renewable devices in Welsh waters (on behalf of the Welsh Assembly Government). Phase 2 - Studies of marine mammals in Welsh high tidal waters.
- Hammond, P.S. et al., 2013. Cetacean abundance and distribution in European Atlantic shelf waters to inform conservation and management. *Biological Conservation*, 164, pp.107–122.
- Hastie, G.D., Wilson, B. & Thompson, P.M., 2006. Diving deep in a foraging hotspot: acoustic insights into bottlenose dolphin dive depths and feeding behaviour. *Marine Biology*, 148(5), pp.1181–1188.
- Heerfordt, A., Møhl, B. & Wahlberg, M., 2007. A wideband connection to sperm whales: A fiber-optic, deep-sea hydrophone array. *Deep Sea Research Part I: Oceanographic Research Papers*, 54(3), pp.428–436.
- Johnson, M., Partan, J. & Hurst, T., 2013. Low complexity lossless compression of underwater sound recordings. *The Journal of the Acoustical Society of America*, 133(May), pp.1387–98.
- Leaper, R., Gillespie, D. & Papastavrou, V., 2000. Results of passive acoustic surveys for odontocetes in the Southern Ocean. *Journal of Cetacean Research and Management*, 2(3), pp.187–196.
- Leaper, R. & Gordon, J., 2012. *Marine Mammal Acoustic and Visual Surveys - Analysis of Neart Na Gaoithe data. Appendix 13.5 Neart Na Gaoithe Environmental Statement.*
- Linnenschmidt, M. et al., 2013. Biosonar, dive, and foraging activity of satellite tracked harbor porpoises (*Phocoena phocoena*). *Marine Mammal Science*, 29(2), pp.E77–E97. Available at: <http://doi.wiley.com/10.1111/j.1748-7692.2012.00592.x>.
- Macaulay, J., Malinka C., Coram, A., Gordon J. & Northridge, S. (2015) The density and behaviour of marine mammals in tidal rapids. Sea Mammal Research Unit, University of St Andrews, Report to Scottish Government, no. MR7.1.2., St Andrews, 53pp.
- Madsen, P.T. & Wahlberg, M., 2007. Recording and quantification of ultrasonic echolocation clicks from free-ranging toothed whales. *Deep-Sea Research Part I: Oceanographic Research Papers*, 54(8), pp.1421–1444.
- Miller, B. & Dawson, S., 2009. A large-aperture low-cost hydrophone array for tracking whales from

- small boats. *The Journal of the Acoustical Society of America*, 126(5), pp.2248–2256.
- Mohl, B. & Andersen, S., 1973. Echolocation: high-frequency component in the click of the harbour porpoise (*Phocoena ph. L.*). *The Journal of the Acoustical Society of America*, 54(5), pp.1368–1379.
- Roy, N., Simard, Y. & Gervaise, C., 2010. 3D tracking of foraging belugas from their clicks : Experiment from a coastal hydrophone array. *Applied Acoustics*, 71(11), pp.1050–1056.
- Villadsgaard, A., Wahlberg, M. & Tougaard, J., 2007. Echolocation signals of wild harbour porpoises, *Phocoena phocoena*. *Journal of Experimental Biology*, 210(1), pp.56–64. Available at:
- Wahlberg, M., 2002. The acoustic behaviour of diving sperm whales observed with a hydrophone array. *Journal of Experimental Marine Biology and Ecology*, 281(1-2), pp.53–62.
- Watkins, W.A. & Schevill, W.E., 1971. *Four hydrophone array for acoustic three-dimensional location*, Woods Hole, MA: Woods Hole Oceanographic Institution.
- Wiggins, S.M., McDonald, M. a. & Hildebrand, J. a., 2012. Beaked whale and dolphin tracking using a multichannel autonomous acoustic recorder. *The Journal of the Acoustical Society of America*, 131(1), p.156.
- Wilson, B. Batty, R. S., Daunt, F. & Carter, C. (2007) Collision risks between marine renewable energy devices and mammals, fish and diving birds. Report to the Scottish Executive. Scottish Association for Marine Science, Oban, Scotland, PA37 1QA

8.1 External Data

The bathymetry data used in this report were collected and processed by Dr Jim Bennell and associated technical support staff based within the School of Ocean Sciences via the Bangor University led 'SEACAMS' project (Grant number: [80284](#)) which is part funded by the European Regional Development Fund through the Welsh Government.

8.2 Acknowledgements

Thanks to SEACAMS and especially Gemma Veneruso (SEACAMS research officer) for help organising and support during fieldwork.