



Appendix 1: Constructing the KE Buoy



Jamie Macaulay*¹, Jonathan Gordon¹, Doug Gillespie¹, Chloe Malinka¹,
Mark Johnson¹, Simon Northridge¹

¹Sea Mammal Research Unit, Scottish Oceans Institute, University of St Andrews,
St Andrews, Fife, KY16 8LB, UK

*jdjm@st-andrews.ac.uk

1 Introduction

This Appendix details how to construct a PLABuoy, including building the buoy, waterproofing electronics and building the hydrophone array. Figure 1 shows a diagram of the buoy, and details where each of the components discussed in the following sections fits.

There are four main components to the buoy:

1. The surface buoy, which provides floatation as well as housing a 12V battery and the electronics box.
2. The electronics and computers which are housed in a waterproofed box (Peli™ case) within the surface buoy or Tub.
3. A 4 element hydrophone array which hangs below the surface buoy.
4. A 4 element “tetrahedral array” which is clamped to the cable of the vertical array in mid water.
5. A clump of chain ~15-20kg attached at the bottom end of the vertical array to hold it taught in the water column and a lifting line.

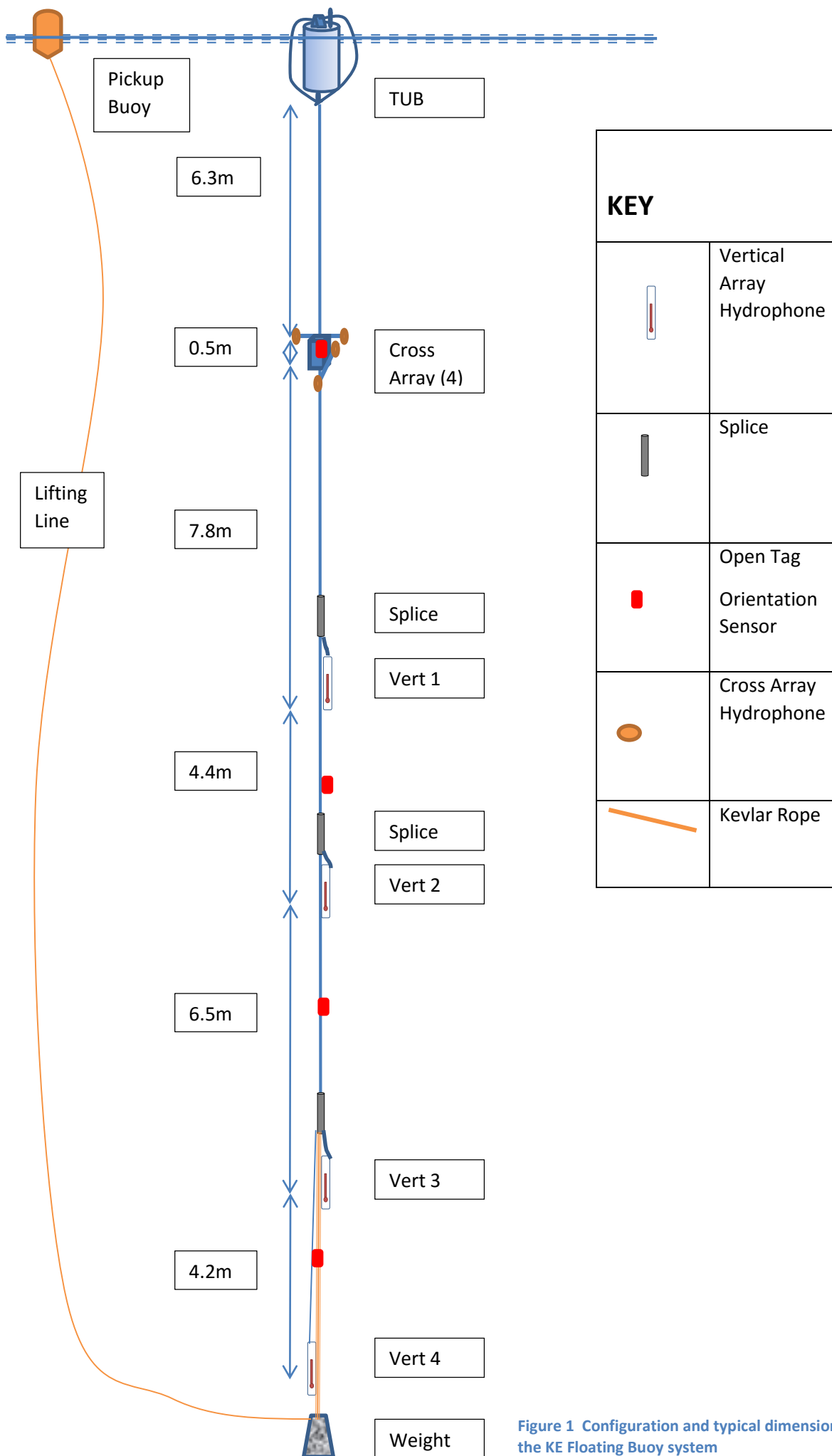

Figure 1 Configuration and typical dimensions for the KE Floating Buoy system

2 The Main Buoy and Primary Waterproof Housing

The main buoy and first waterproof container is provided by a 60L plastic watertight drum (Figure 2).

<http://www.solentplastics.co.uk/marine-storage-products-boxes/waterproof-and-irtight-kegs-drums/product/DRUM60/60-litre-open-top-air-watertight-heavy-duty-plastic-storage-drum>



Figure 2 Watertight drum used as primary housing and float

This was chosen because it represented a highly cost effective waterproof floating container which was also light and easy to handle.

(Note: No leaks were detected when a tub (without any alterations to the lid) was submerged to a depth of about 1.5m in the SMRU seal pool for several hours. However, the buoy was deformed by

pressure and leaked when it was taken down to a ~20m after it snagged on the bottom in a strong current in Kyle Rhea.)

The lid on tubs of this type are locked in place by a lever-arch-tensioned band made of galvanised steel. We had concerns about how well this would stand up to marine use so sprayed it with an additional coat of galvanised paint and also sprayed its hinges with automotive underseal.

To provide an attachment point for the main weight of the hydrophone array beneath the barrel we constructed a “girdle” from 5cm Terylene (Dacron) webbing tape (Figure 3).



Figure 3 Drum with webbing “girdle”. The white plastic tube to the right serves as a holder for a short “mast” that supported a flag and a GPS logger.

The “girdle” included two horizontal bands. One just below the neck of the barrel and above the handles and the second just above the base. These were tightened by a buckle-lashing configured using two shackles and strong line.



Figure 4 Shackles and lashing used to tension the cross straps

Two longer straps had hand-sewn eyes at each end that looped over the top horizontal band. A second set of eyes were stitched around the bottom band to hold it in place. These straps passed around a large stainless steel thimble and was whipped in place to provide a strong mounting eye below the barrel for the hydrophone array to be attached to (Figure 5).

A few patches of polyurethane wood glue which were placed between the webbing and abraded and de-greased sections of the buoy also helped to fix the straps in place.



Figure 5 Vertical straps in the “girdle” are brought together and pass around a stainless thimble below the tub to provide the main attachment point for the vertical array

Power Supply

A sealed maintenance-free lead acid battery was fitted in the bottom of the tub. This was achieved using builders foam. Cling film and masking tape were applied to parts of the battery to protect the terminals so that they could be accessed once the foam had set (Figure 6).

A two core cable with a two pin Bulgin waterproof inline connector provided a power lead from the battery

(BULGIN PX0736/P Circular Connector, Buccaneer Standard Series, 2, Pin, Screw, Cable

<http://cpc.farnell.com/webapp/wcs/stores/servlet/ProductDisplay?catalogId=15002&langId=69&urlRequestType=Base&partNumber=CN08567&storeId=10180>

<http://cpc.farnell.com/webapp/wcs/stores/servlet/ProductDisplay?catalogId=15002&langId=69&urlRequestType=Base&partNumber=CN08602&storeId=10180>)

(The battery shown in Figure 6, a LEOCH LPC12-55 Rechargeable Battery, Lead Acid, 55 Ah, 12 V proved to be slightly too high when first installed and prevented the Peli case electrical enclosure from easily fitting inside the tub; the battery was subsequently mounted on its side (as shown). This didn't seem to pose any problems but a slightly lower battery which could be mounted with the correct orientation would be optimal for future builds.)

<http://cpc.farnell.com/webapp/wcs/stores/servlet/ProductDisplay?catalogId=15002&langId=69&urlRequestType=Base&partNumber=BT05519&storeId=10180>

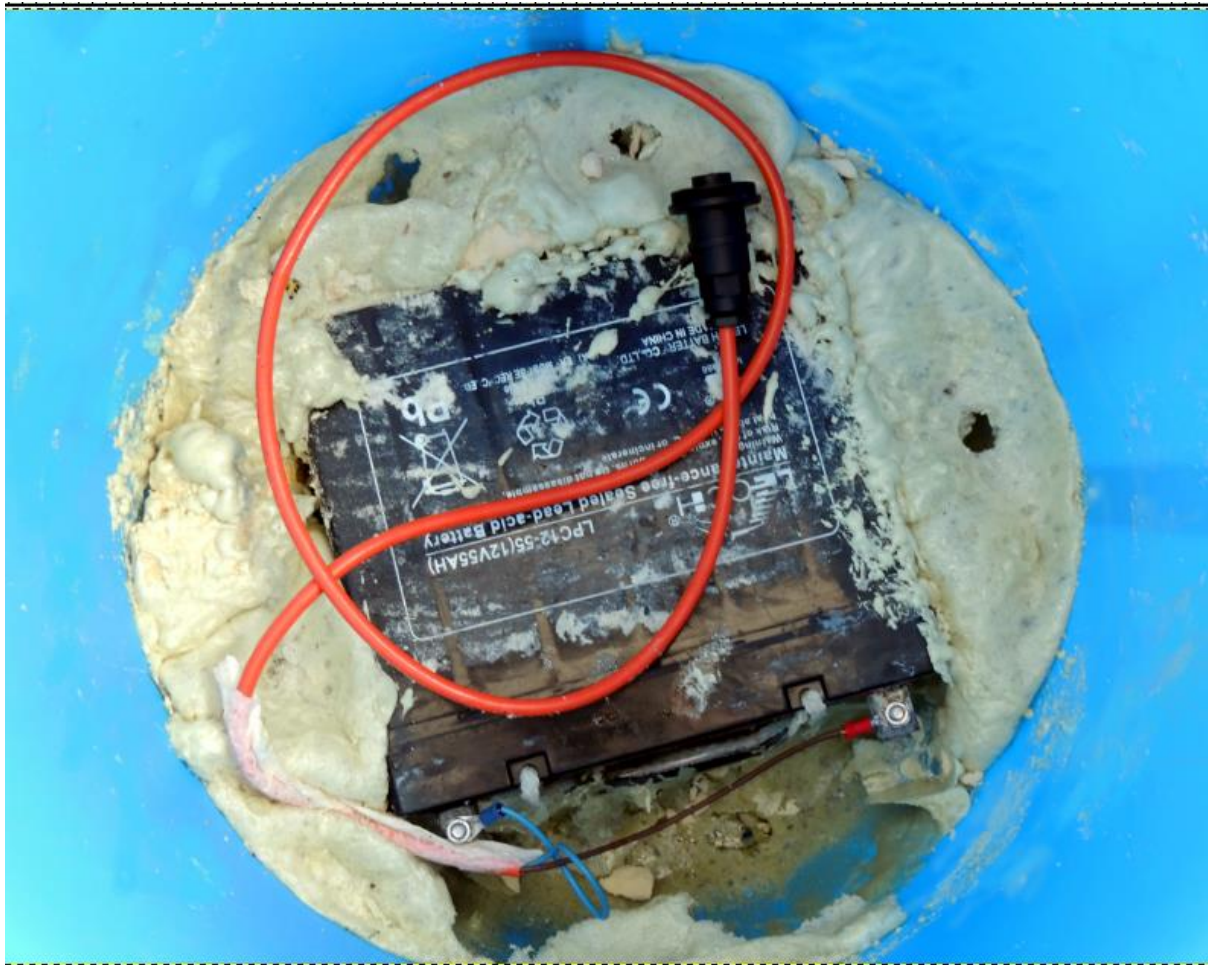

Figure 6 A sealed lead acid battery held in the bottom of the tub using builders foam.

The tub also needs to contain the electronics and computer. These were housed in a separate waterproof box, a Peli case (Peli Storm IM2100) See later for details.

The lid of the tub was strengthened by clamping a 25cm diameter circle of varnished 12mm marine ply on either side. Sikaflex sealant was applied liberally to both pieces of plywood and a ring of nuts, bolts and washers were used to clamp the two pieces together with the abraded and degreased lid sandwiched between them

This varnished plywood strengthened the lid and provided a base for various attachments.

Bulgin Buccaneer 900 connectors (10 pin) were used to provide waterproof connectors terminating the cable from both the vertical and cross arrays.

<http://uk.rs-online.com/web/p/industrial-automation-circular-connectors/8418932/>

Two Bulgin Buccaneer 900 bulkhead adapters were fitted to the lid, side by side and pointing in opposite directions to provide the connection between hydrophone cable and the electronics within the tub (Figure 7 and Figure 10).

<http://uk.rs-online.com/web/p/circular-connector-adapters/3444295/>

<http://uk.rs-online.com/web/p/industrial-automation-circular-connectors/0575747/>



Figure 7 Bulgin 900 bulkhead adapter and waterproof dust caps

Cables connected to the plug inserts passed through an additional cable gland on the wooden base and through the lid and on to the waterproof instrument case within the tub.

Two other cables were also brought through the lid:

1. A cable for a serial button GPS:

<http://usglobalsat.com/p-57-br-355.aspx#images/product/large/57.jpg>

This was brought through a standard deck gland (Figure 8).



Figure 8 Cable Glands used on the lid. These were for the GPS and WiFi cables.

2. A coax cable connecting the Wi-Fi aerial to an Alfa AWUS048NH WiFi router.

http://www.amazon.co.uk/gp/product/B003UVS5BW?psc=1&redirect=true&ref=oh_aui_search_detail_page

This was mounted within a customised container consisting of a specially turned ABS fitting with a crimped polyurethane tube slipped over it. The flanged abs fitting was sealed with Sikaflex and held in place using stainless screws. The polyurethane tube was sealed by heating one end with a hot air gun until the walls were pliable and then clamping in a bench vice until the polyurethane had cooled and set (Figure 9).



Figure 9. Custom enclosure for Wi-Fi aerial consisting of specially turned plastic base and a length of sealed polyurethanes tube



Figure 10. The lid of the PLABuoy. This contained connections for the electronics and hydrophones array and a GPS and Wi-Fi aerial.

(Note: After the tub had been submerged for several hours there was some water ingress into the bulkhead adapter causing corrosion to the cable. In a future build we would favour bringing the USB GPS cable through the bulkhead adapter rather than a cable gland and filling both bulkhead adapters with polyurethane potting compound to make a solid, totally sealed unit.)

In our first version, the lid was connected permanently to the waterproof instrument case by two hydrophone cables and cables for the USB GPS and the WIFI aerial (Figure 11). Adding waterproof connectors in these leads to allow the electronics case to be separated would have some practical benefits but would add some complexity and expense.



Figure 11. The Peli case was permanently connected to the lid. Future iterations of the PLABuoy would be more practical if plugs were used to connect the Peli case to the lid.

3 Electronics Case

The main electronics were fitted within a waterproof Pelican Case (Figure 12). Cables connecting the two Buccaneer plugs for the hydrophone arrays and the external GPS and Wi-Fi aerial on the lid were brought through the case using waterproof cable glands which were downward facing when the case was placed in the buoy for deployment. The case and the lid of the buoy were thus continuously connected. A power lead with a 2 pin buccaneer in-line socket to connect to the battery lead was also brought through a cable gland in the side of the box.

The cRio and amplifier were mounted on pieces of varnished plywood attached to the inside of the box. Other components were held in place using Velcro.

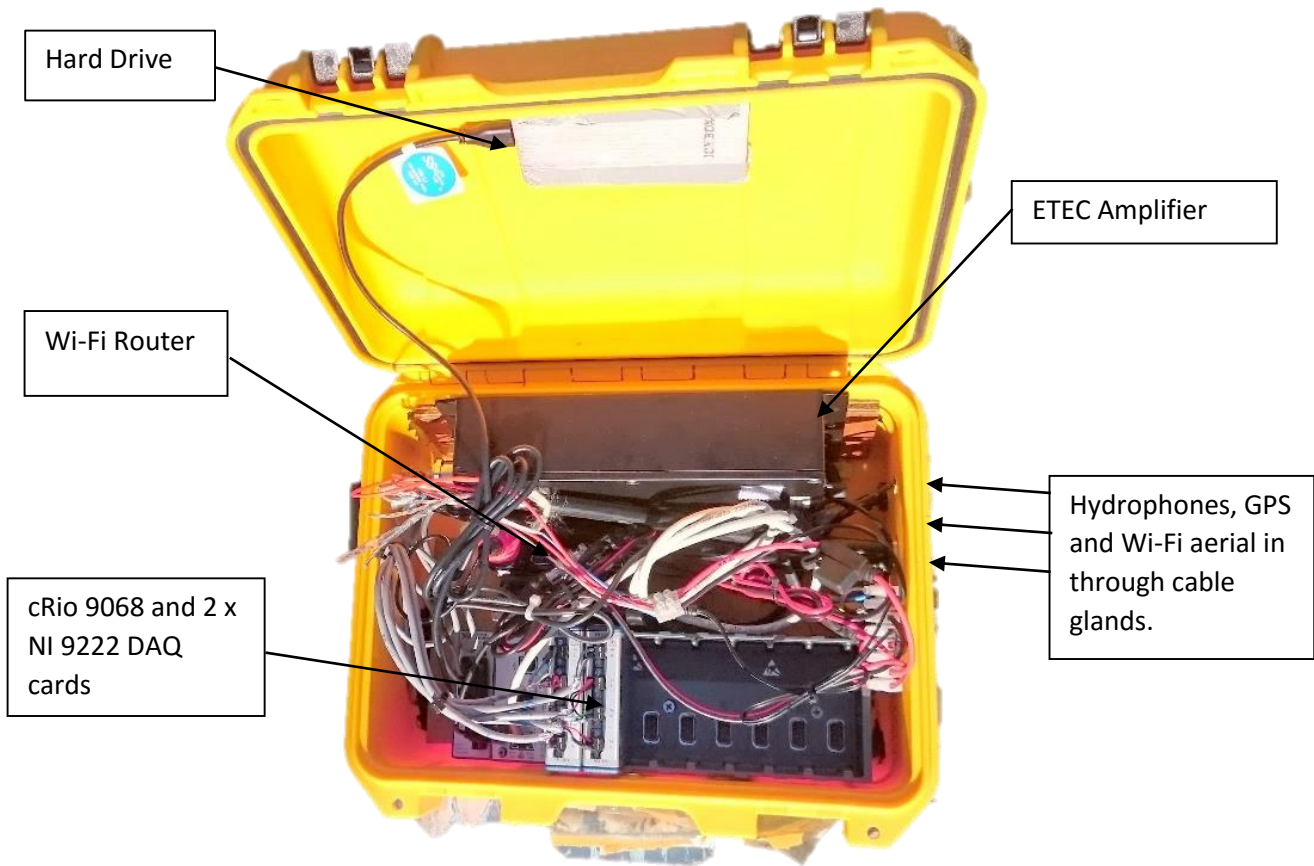

Figure 12 Instrument case containing the cRio computer, amplifier and Wi-Fi router.

4 The Hydrophone Array

4.1 Vertical Array

The cable of the vertical array must bear the strain from the terminal weight when the system is deployed and we chose to use strengthened cable originally intended for towed hydrophone arrays. The cable contained 5 x .22 mm twisted pairs to carry signal and return from the balanced preamps of each hydrophone. The screen around each twisted pair was used to carry 0V, the cable had one a 5mm core which provided +12v to the hydrophone preamps and an overall screen. A Kevlar braid provided strength (500kg breaking strain) and gave additional protection.

(Note: Strengthened cable of this type is a specialist item and difficult to purchase in short quantities.

Some cable manufactures e.g. Hydro cable in Aberdeen,

http://www.hydrogroupplc.com/hydro_cable.html do sell short lengths of ex-stock offcuts on

occasion. We purchased cable from Vanishing Point Marine Ltd <http://vpmarine.co.uk/> who hold cable stock for building towed arrays.)



Figure 13 Bulgin 900 10 pin plugs. These are used to connect the hydrophone array to the buoy.

Each cable connected to one of the bulkhead connectors on the lid via a Bulgin 900 10 pin plug.

A Kellum's grip at the top end of the cable provided a means of attachment at the buoy. Two Kellum's grips facing each other were also incorporated in the midsection of the hydrophone and could be connected to each other to shorten the array for use in shallower water.

(Kevlar Kellum's grips were purchased from Slingco <http://cablegrip.co.uk/noncon.php> item ZCS140)

Kevlar strengthened tow cable extended from the surface Tub through two intermediate splices to the lower splice. At each splice a ~0.5m length of lighter Proplex toughened Ethernet cable was used to connect a hydrophone in an oil filled tube (e.g. Figure 16) back to the main cable.

The final splice terminated in a stainless eyebolt and two lengths of the lighter Ethernet cable (0.5 m and 4.5m) which made connections to the deepest two hydrophones. A length of non-stretch 12mm abseiling rope connected the stainless eye bolt to the terminal weight (Figure 14).



Figure 14 The lower termination of the vertical array cable.

4.2 Vertical Array Hydrophones

Some of the most delicate components in any PAM systems are the hydrophones. These can easily be damaged on a working vessel, for example by a person stepping on an exposed element or

scraping them on the side of the boat during deployment/retrieval. As the PLABuoy was to be deployed from a small vessel, often in rough conditions, it was essential to ruggedise the hydrophone array so that it could withstand the inevitable knocks associated with working on a boat, hitting the seabed in strong tidal currents and continuous deployment/recovery over a period of weeks. Hydrophones and their associated pre amps were therefore placed inside acoustically transparent oil-filled polyurethane tubes (Figure 16). These casings proved effective at protecting hydrophones and amplifiers from the usual wear and tear in the field and no hydrophone elements failed during any of the field trials.

Each of the 4 hydrophones in the vertical array was mounted in oil filled 33mm ID polyurethane tubes. This tube was swaged onto custom produced ABS plastic fittings (Figure 15). The front fitting was threaded to take a cable gland. The lighter hydrophone cable passed through this and the fitting and was filled with potting compound once the electrical connections had been made.

The rear fitting contained a threaded hole which could be closed by a machine screw with O ring. This allowed the tube to be filled with oil.



Figure 15 ABS end pieces for hydrophone housings. Front piece has 20mm cable gland fitted. Rear piece is fitted with cable gland. Pieces are turned up to fit polyurethane tube. Approx. diameter 27mm length 50mm.

These fittings, swaging tube, swaging tubes and Isopar Oil were obtained from Vanishing Point Marine Ltd. <http://vpmarine.co.uk/>

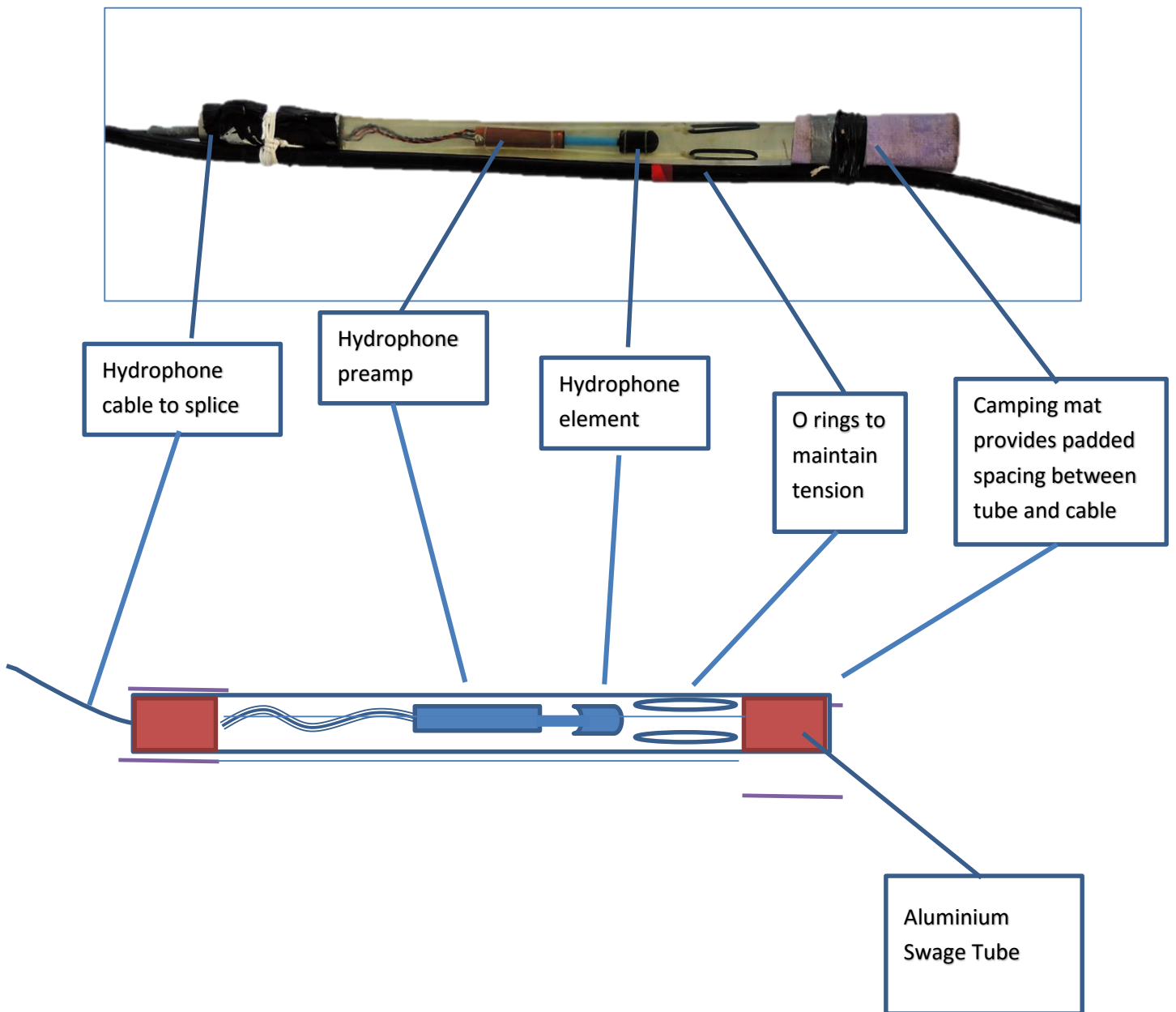

Figure 16 A diagram of the vertical array hydrophone mounted within a polyurethane tube

4.3 Tetrahedral Cluster Array

The tetrahedral cluster array was made from two pairs of hydrophones with each pair mounted in a “T” mount which was assembled from 25mm PVC pipe and fittings (Figure 17). The pipe and fittings were obtained from Pipestock UK and their catalogue numbers for the parts used are shown in Figure 17.

<https://www.pipestock.com/pvc>

Each hydrophone in the cross array was enclosed in a 300 mm length of sealed 31 mm diameter polyurethane tube swaged onto the 25mm mm PVC pipe using aluminium swaging tube.

To seal the polyurethane pipe, one end was heated using a hot air gun until pliable then crimped in a vice and held there until it had cooled and bonded.

The T section units were filled with oil through the end cap.

Mounting the hydrophones within polyurethane tube in this way worked well. The tube provided a transparent yet robust enclose which was sufficiently flexible to avoid damage when being handled in small vessels.

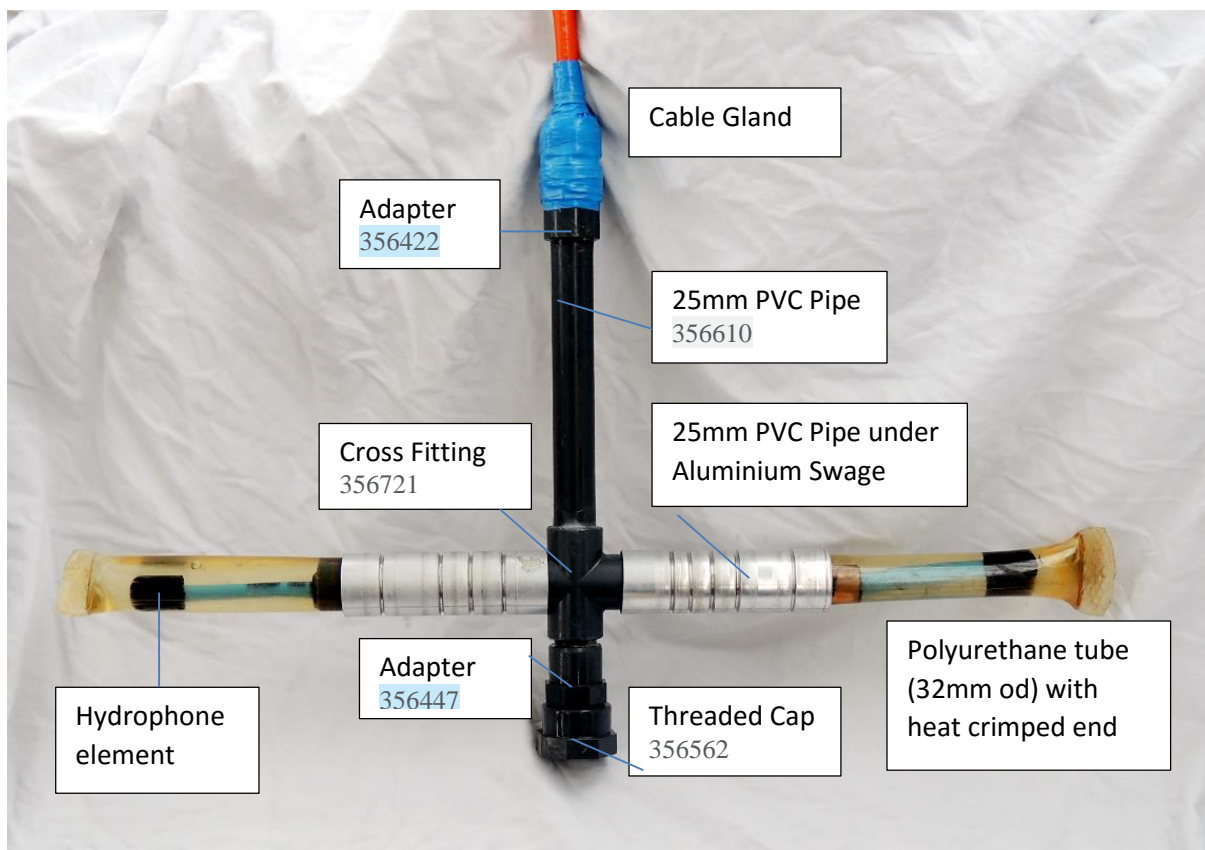

Figure 17 Two hydrophones in a “T” configuration. Two of these mounted at right angles to each other comprised the cross array. Most of the body was made from PVC pipe fitting sand these and their catalogue numbers are labelled.

Other aspects of the design of the cross array was not entirely successful. The cable glands at the top of the T units had a tendency to leak and to cure this in the field each unit was drained of oil and epoxy was injected just above the cable gland to solidly pot the cable to the gland and pipe.

We also found the units to be quite fragile. The PVC pipe snapped on one occasion (possibly it had been made brittle by the oil). The construction of the cross array is certainly an area that would benefit from further improvement.

The two T pieces were mounted at right angles to each other on a mount and clamped to the cable of the vertical array (Figure 18).

The cross array mount consisted of two pieces of Tufnol plastic 100 mm by 584 mm. Each had a semi-circular channel machined down the mid line and 6 nuts and bolts were used to clamp it firmly on to the strengthened cable of the vertical array (Figure 18).

A pair of machine screws threaded into the plastic were used to mount an OpenTag IMU in a consistent orientation.

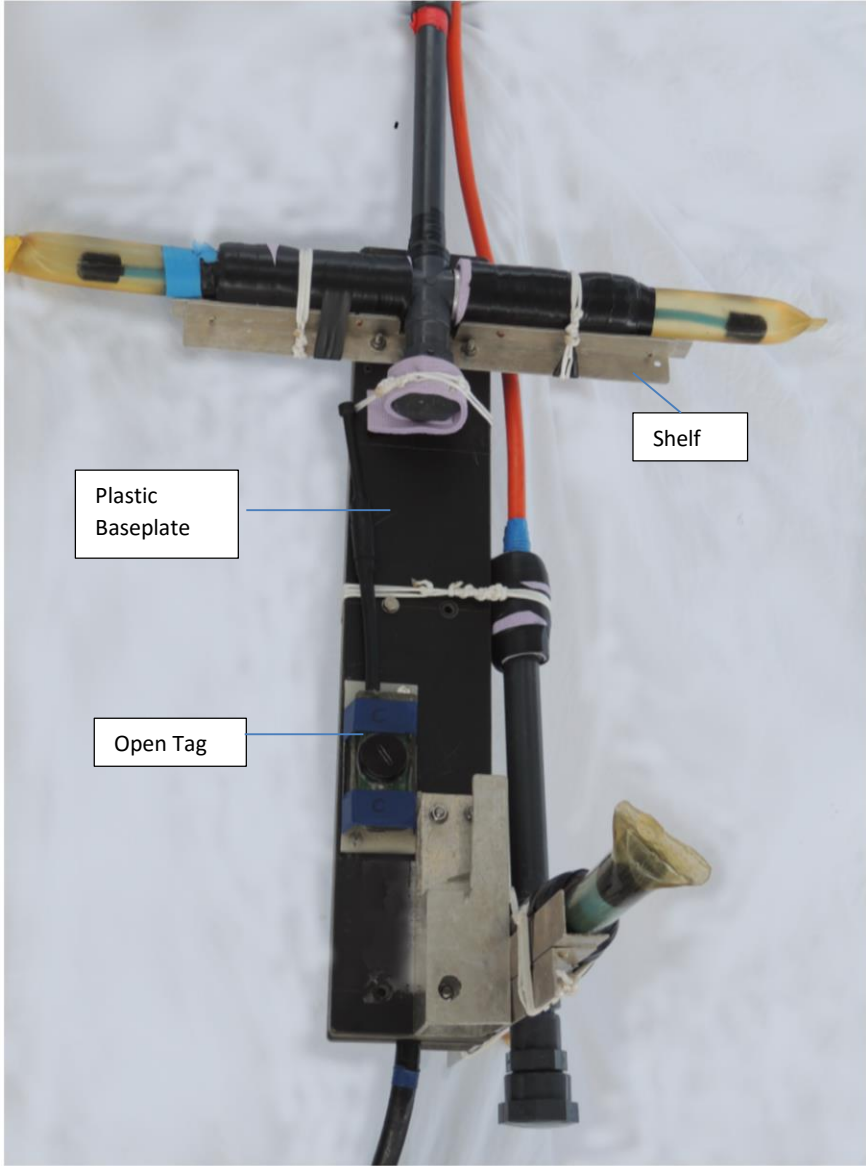

Plastic
Baseplate

Shelf

Open Tag

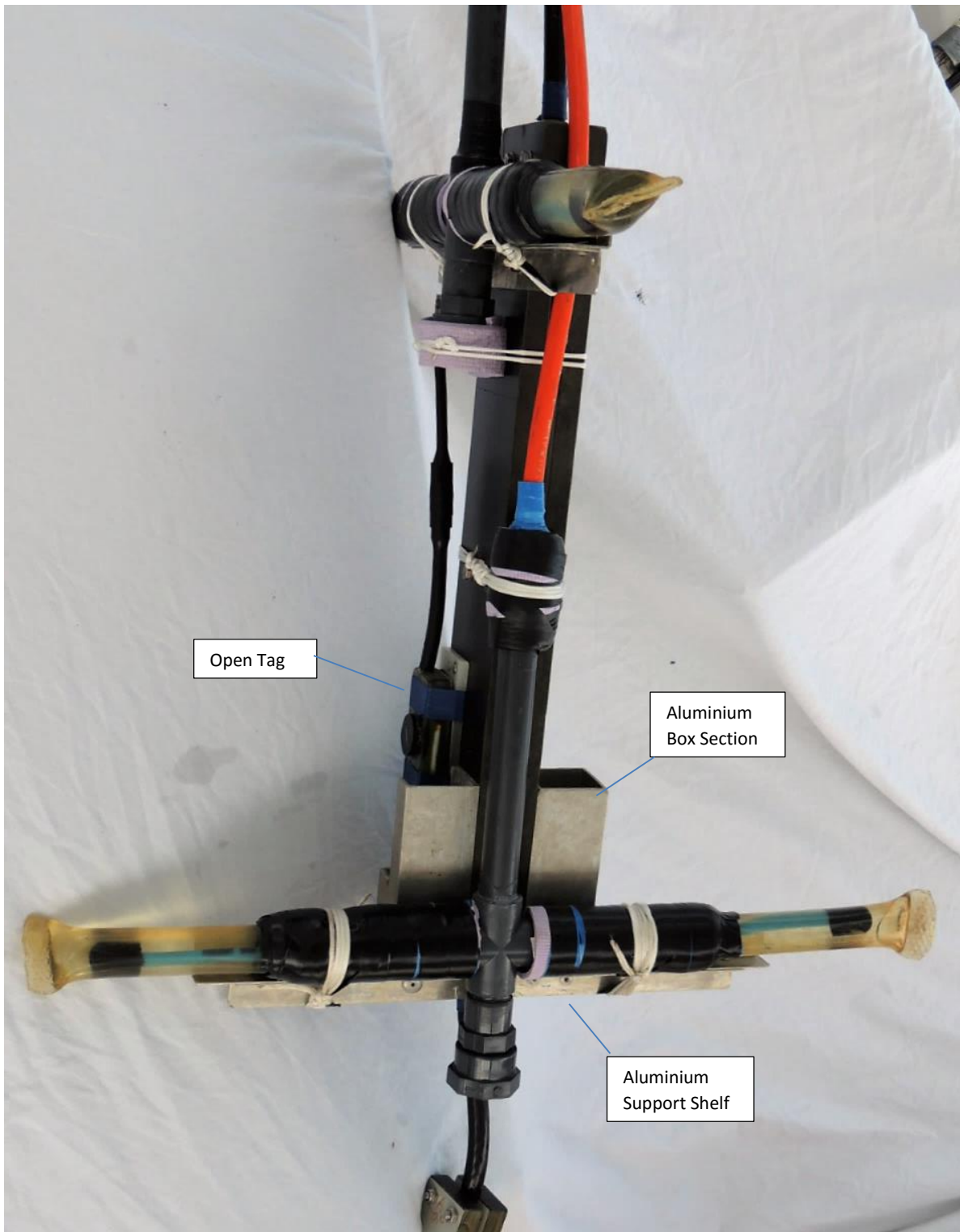

Figure 18 Two views of the cross array made by attaching two “T” pieces to a plastic and aluminium block which was clamped to the cable of the vertical array. The open tag which provided information on the orientation of the array can be seen as can the aluminium box sections holding the second T section at right angles to the first.

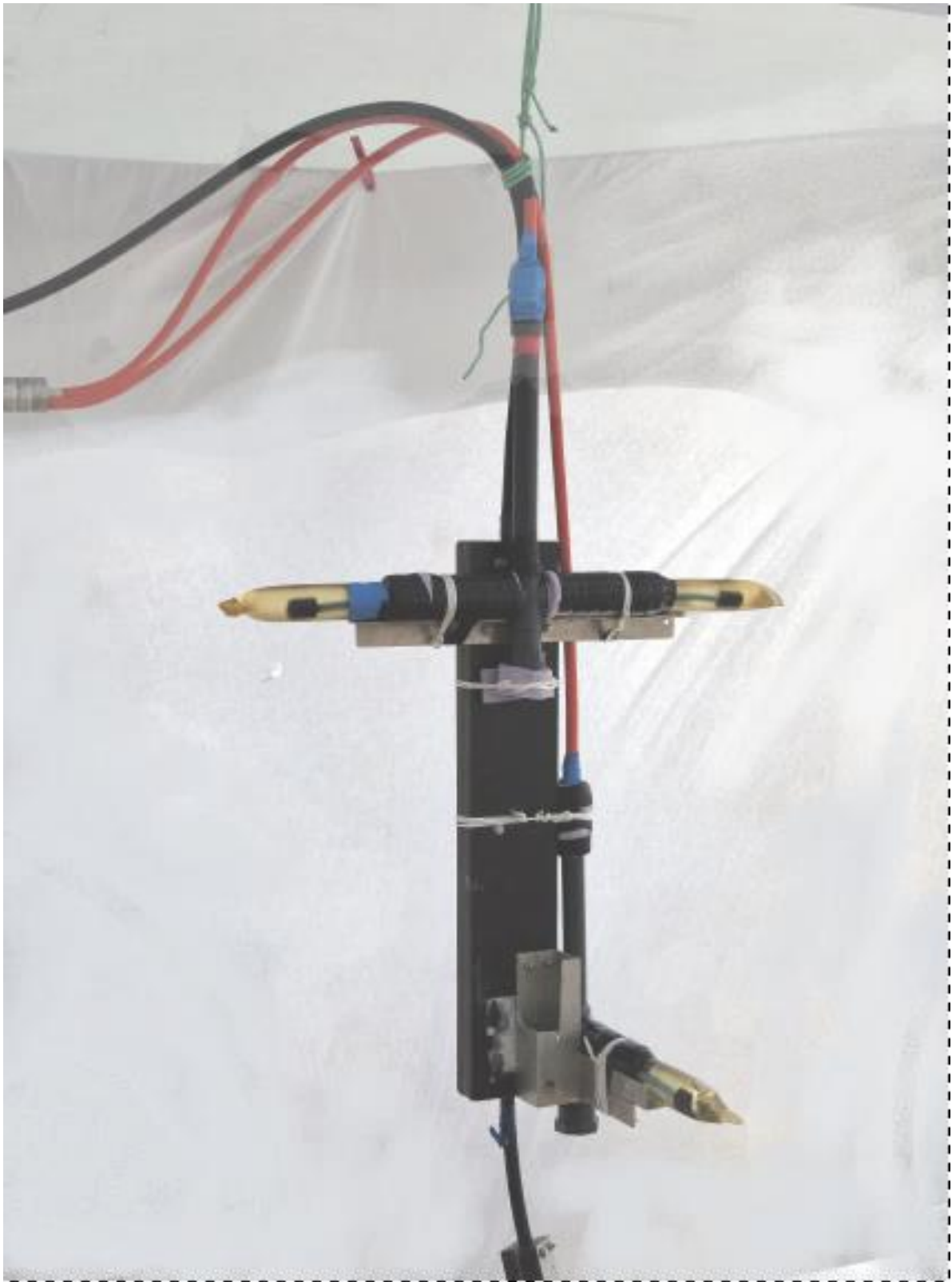

Figure 19 Another view of the cross array. The thicker black cable is the load bearing cable of the vertical array. The two orange cables are spliced together and continue as a single cable to the tub.

Two pieces of aluminium box section (50mm x 50mm and 150mm long) were bolted to the plastic base plates aligned with the edges to provide a second attachment point for the other “T” piece at right angles to the Tufnol base.

An attachment “shelf” for each T piece was configured by riveting two 40cm lengths of 2 mm “L” section aluminium together then bolting these to both the plastic block and the box sections.

The hydrophone T sections were held in place on these “shelves” using twine whippings with pads of closed foam camping mat being used to provide padding and reduce telegraphed noise.

4.4 Orientation Sensors

OpenTag™ data loggers (<http://loggerhead.com/collections/all/products/opentag-datalogger>) were used as orientation sensors to allow the “shape” and orientation of the array to be measured and modelled. (See Appendix 2 for procedures and software).

Open tags were fixed to the strengthened cable of the vertical array using a clamp consisting of two rectangular blocks of Tufnol plastic with a semi-circular channel machined along the middle of each so that they could fit around and be clamped firmly onto the vertical array cable. Four machine screws and bolts were used to tighten the clamp in place. A pair of threaded holes in one of the Tufnell plates allowed the OpenTag to be removed and re-fixed in the same orientation as required.



Figure 20 Mount for Open Tag on the cable of the vertical array.

5 Electronics

A National Instruments cRio data acquisition system with two NI 9222 modules and a 10 channel ETEC amplifier formed the core of the PLABuoy data acquisition system.

The cRio from National Instruments was chosen as the computing and data acquisition platform because it provided the best balance between reliability, required development time, availability of open source software and power consumption. The cRio is essentially a low-power embedded computer running a custom version of Linux. It contains a powerful dual core ARM Cortex-A9 processor and an Artix-7 FPGA which can be programmed in LabView. (Labview is a graphical programming language that is relatively easy for users to learn and use). Although programming the FPGA required LabView, a proprietary programming language, the rest of the system is highly flexible, with users able to create programs in multiple open source languages. The typical user shouldn't need to write any additional programs and thus will not need to purchase LabView. National Instruments provide good support for C and C++ with an easy to use library which can communicate with the FPGA and external NI DAQ systems. The cRio hardware is designed to be modular. A range of plug in modules can be added to the system. We used two NI9222 data acquisition (DAQ) modules, each capable of sampling 4 channels at 500kS/s, as our primary sound cards.

Compact, low powered, multi-channel amplifiers which work at harbour porpoise frequencies are difficult to source and so we commissioned ETEC to design and build a compact 10 channel amplifier and filtering system with adjustable gain and filter settings. This can now be readily purchased from ETEC (<http://www.etec.dk/>).

Additional instruments included a serial GlobalSat BR-355-S4 GPS directly connected to the cRio serial port to record positions, an ALFA AP121U wireless router which was connected to the cRio

Ethernet port to allow for wireless communication and a Samsung Evo 500GB external solid state hard drive to save digitised sound and other data.

We chose to use a solid state hard drive because it had a lower power requirement, a higher data rate and was more resilient to movements and knocks than a spinning hard drive.

A summary diagram of the electronics is shown in Figure 21

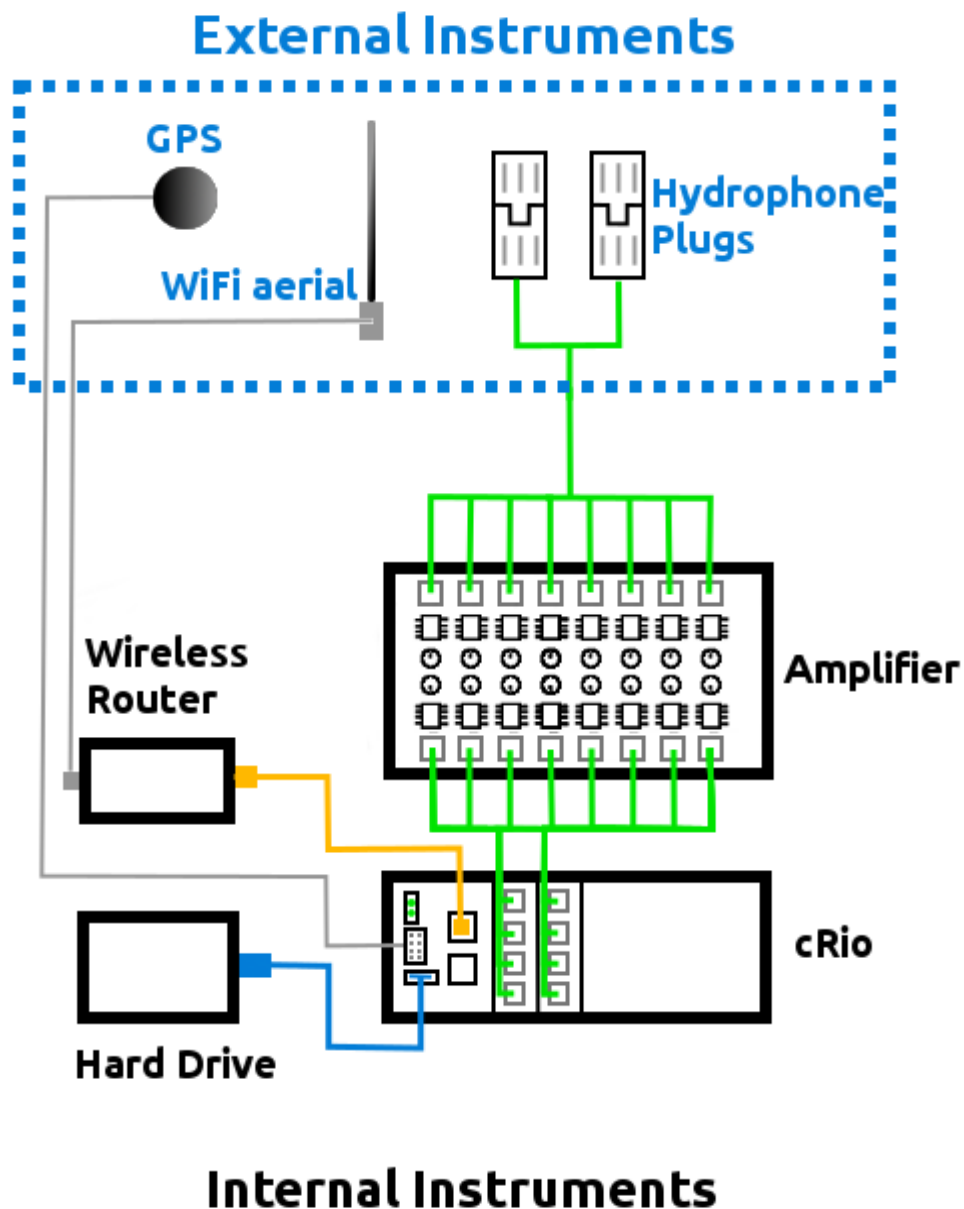

Figure 21 Diagram of PLABuoy electronics. Hydrophones signals are amplified and filtered by a custom 8 channel amplifier. The filtered and amplified signal is then digitised and saved by the cRio. GPS data are also saved to the hard drive and a wireless router allows external users to communicate with the cRio using a smartphone, tablet or laptop

The electronics were mounted inside a Peli Case as shown in section 3. The NI9222 cards were connected to the amplifier by shielded twisted pair cables easily available from electronic stores

e.g. <http://cpc.farnell.com/pro-power/9504eq/cable-four-pair-9504-eq-100m/dp/CB15211>.

Fuses were used on all electronics.

The wireless aerial on the Wi-Fi router was extended using a good quality antenna extension cable (TP-LINK TL-ANT24EC5S).